

 bestaande plattgrond

CONCEPT



opdrachtgever
Landheer/Bremmers
project
Verduurzaming woonhuis
onderdeel
plattgrond bestaand en nieuw

nummer
23055
datum
16-01-2024
gewijzigd
A
B
C
D
E
F
blad
BE-00

Bovenweg 29
6721 HV Bennekom

tel [0318] 493666
info@degijt.nl
www.degijt.nl

ontwerp
getekend
W. van den Brink
schaal
1:50
formaat
A1

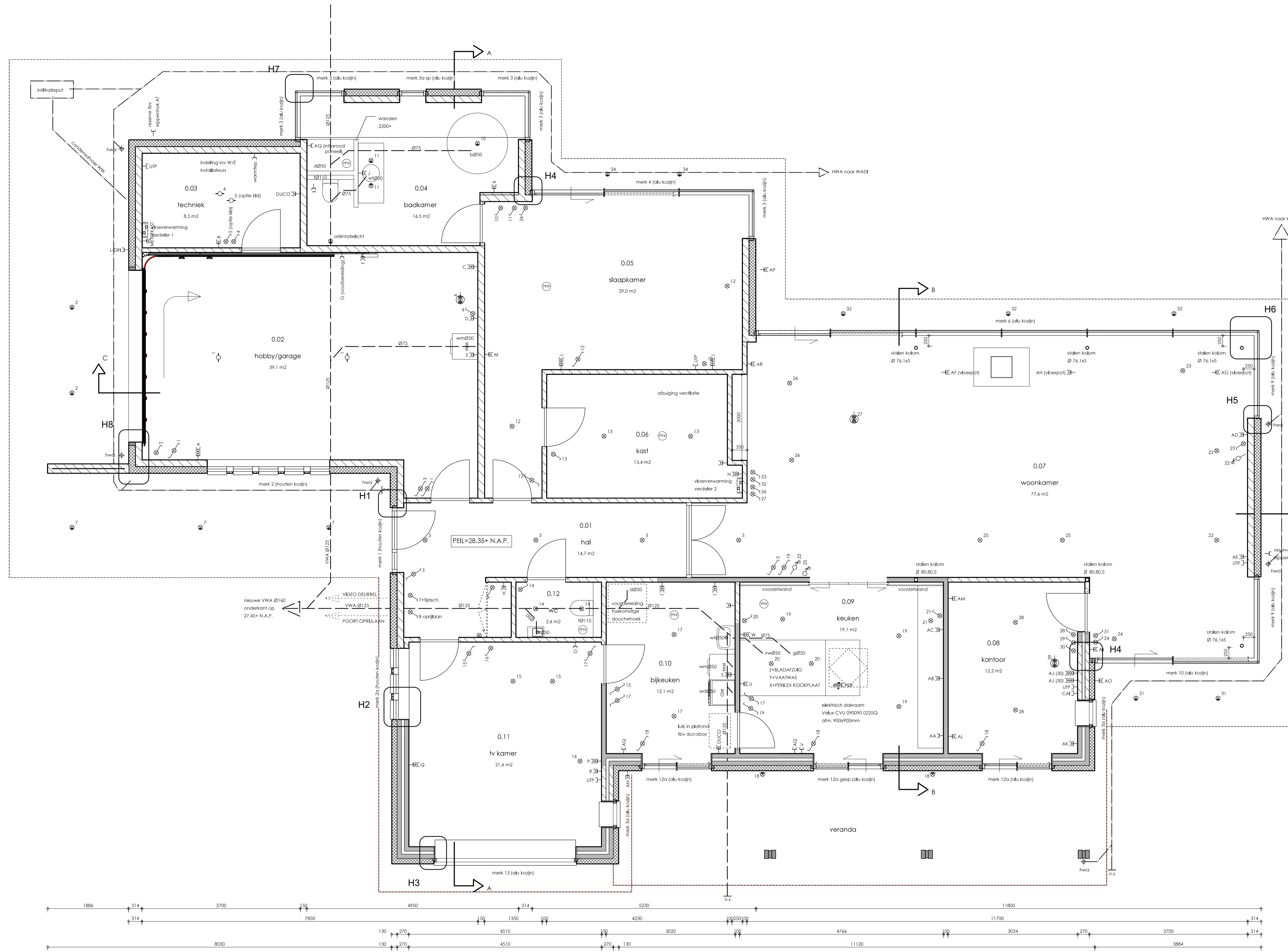

renvooi elektra

- C— enkele wandcontactdoos, geaard
- EC— dubbele wandcontactdoos, geaard
- ECC— 3-voudige wandcontactdoos, geaard
- ECCC— 4-voudige wandcontactdoos, geaard
- ⊙ schakelaar
- ⊙ schakelaar, dimbaar
- ⊙ wisselchakelaar
- ⊙ wisselchakelaar, dimbaar
- ⊙ plafondarmatuur, ledbalk
- ⊙ plafondarmatuur, opbouw, hangende ledbalk
- ⊙ plafondarmatuur, inbouw, downlight
- ⊙ plafondarmatuur, inbouw, downlight, waterdicht
- ⊙ plafondarmatuur, opbouw, hanglamp
- ⊙ wandarmatuur, opbouw
- ⊙ wandarmatuur, opbouw, waterdicht
- ⊙ PER perlex stopcontact inbouw 400V

renvooi riolering

- HWA hemelwaterafvoer
- VWA vuilwaterafvoer
- O.S. ontstoppingshuk
- G gootsteen
- VW vaatwasser
- WM wasmachine
- WD wasdroger
- I toilet
- WI wastafel
- F fontein
- D douche
- B bad

renvooi overig

- (MV) mechanische ventilatie

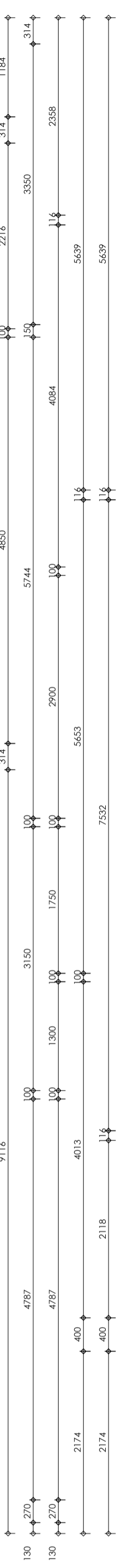

CONCEPT



opdrachtgever
Landheer/Bremmers
project
Verduurzaming woonhuis
onderdeel
begane grond bestaand/nieuw

nummer
23055
datum
02-05-2024
gewijzigd
A 29-05-2024
B
C
D
E
F
blad
WE-01

Bovenweg 29
6721 HV Bennekom

ontwerp
getekend
W. van den Brink

schaal
1:50

formaat
A1

tel 0318) 493666
info@degijt.nl
www.degijt.nl

printdatum: 31-05-2024

bestandnaam: F:\PROJECT\UT-20-2024\bestanden\gmg\230505_02-05-2024\02-05-2024.dwg

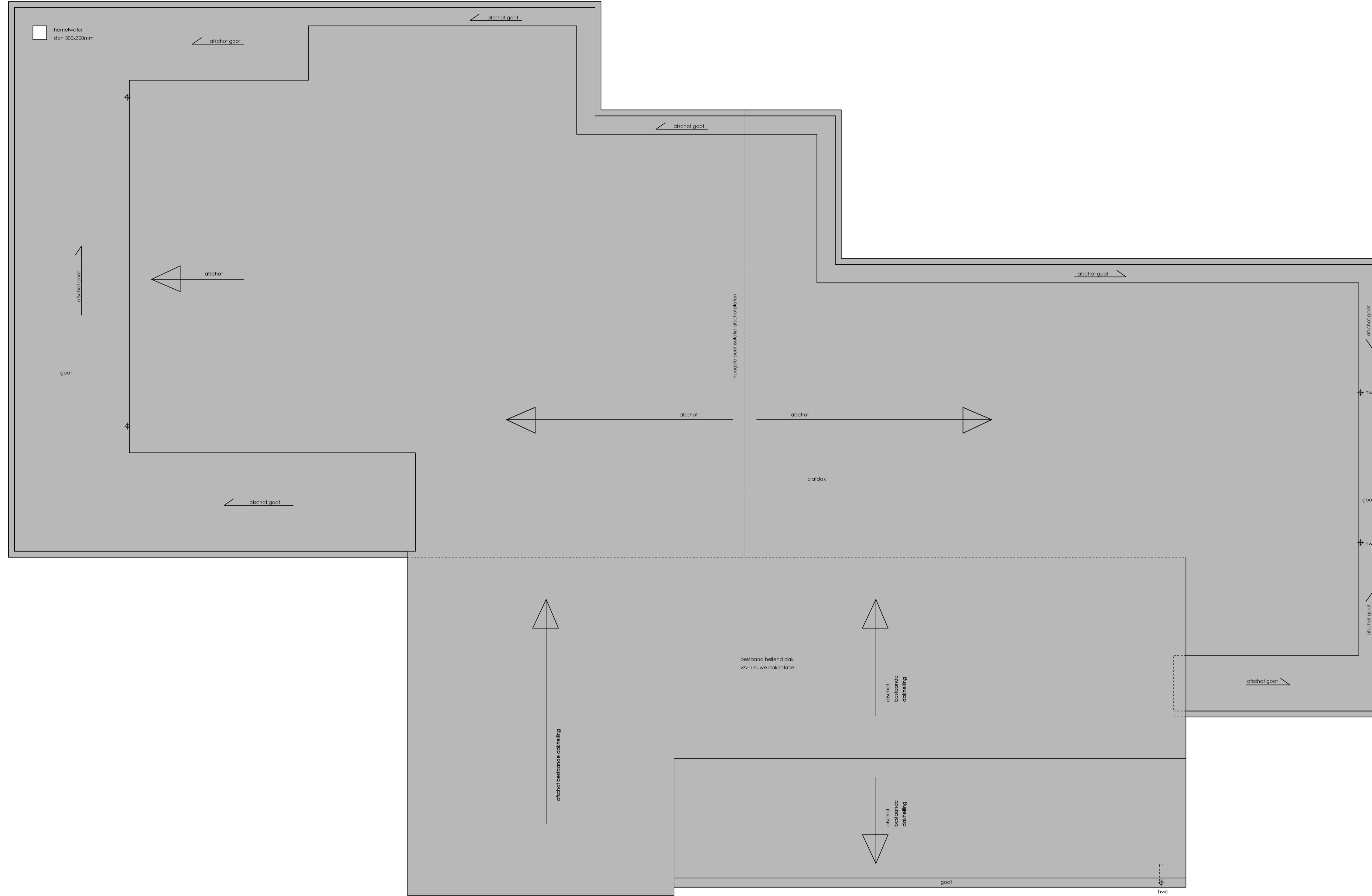

CONCEPT



opdrachtgever
 Landheer/Bremmers
 project
 Verduurzaming woonhuis
 onderdeel
 dakaanzicht nieuw

nummer
 23055
 datum
 02-05-2024
 gewijzigd

Bovenweg 29
 6721 HV Bennekom

ontwerp
 getekend
 W. van den Brink

schaal
 1:50

formaat
 A1

tel (0318) 493666
 info@degijt.nl
 www.degijt.nl

A
 B
 C
 D
 E
 F
 blad
WE-02

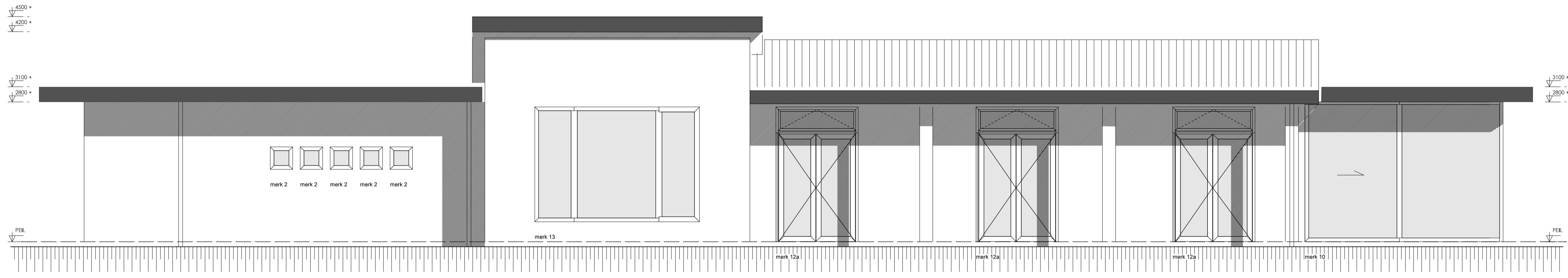

zuidgevel

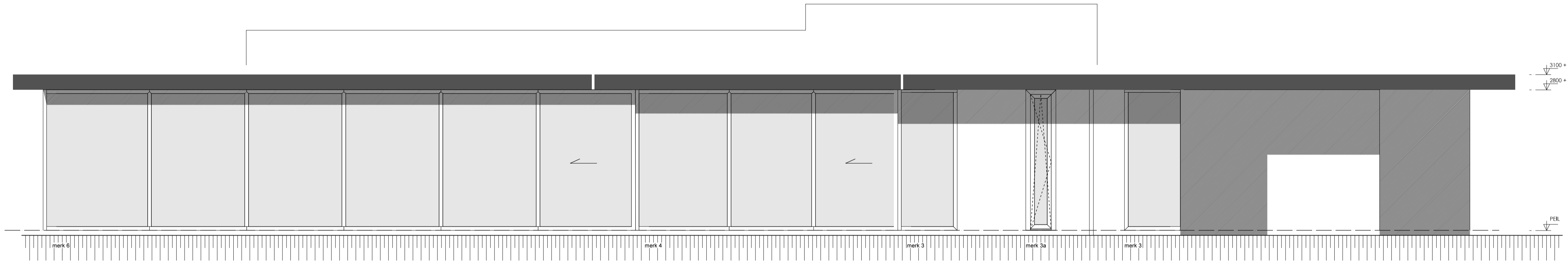

noordgevel

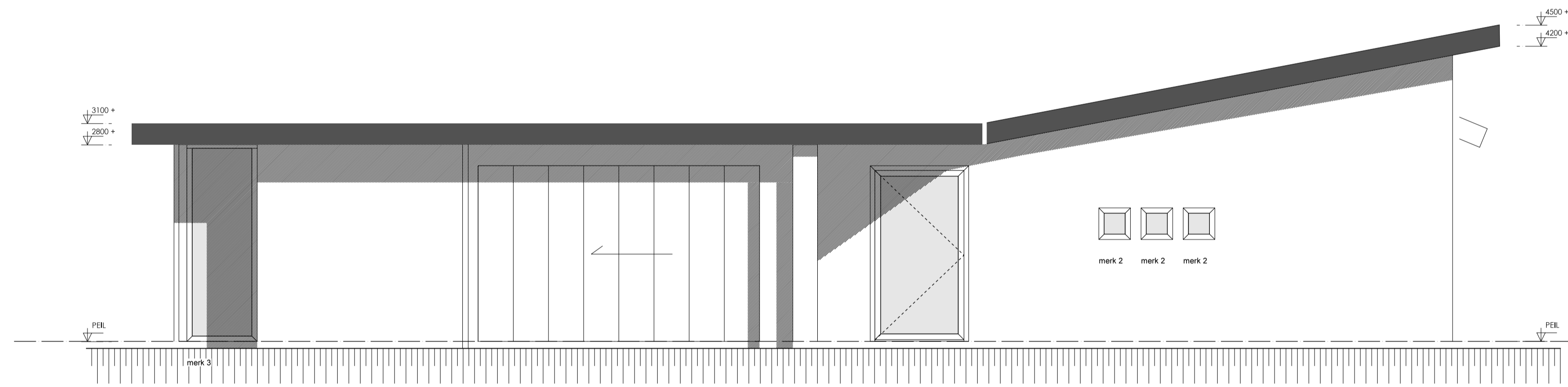

westgevel

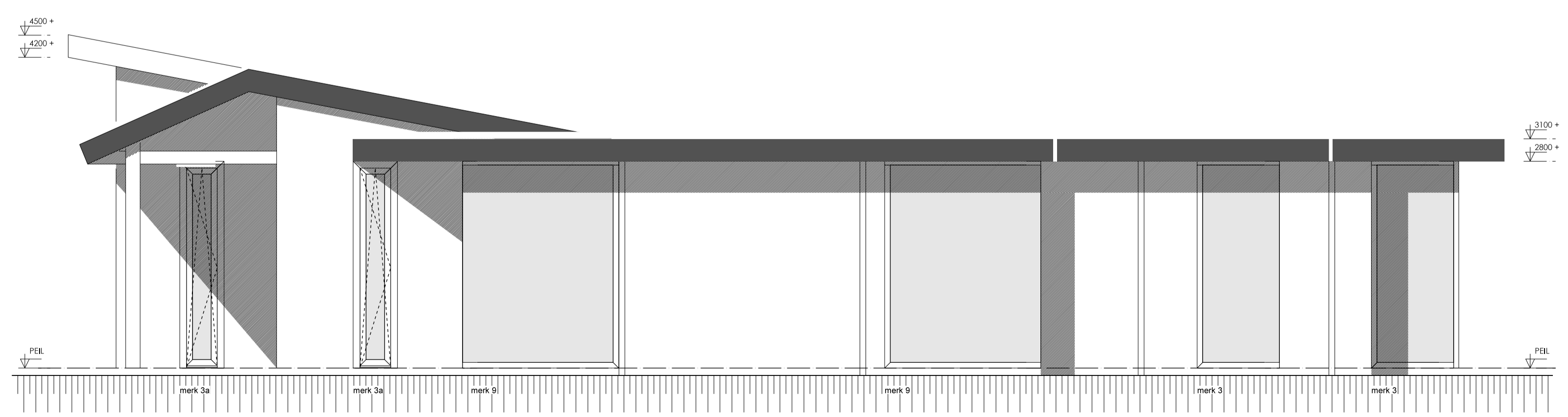

oostgevel

CONCEPT



opdrachtgever
Landheer/Bremmers
project
Verduurzaming woonhuis
onderdeel
gevels nieuw

nummer
23055
datum
16-01-2024
gewijzigd
A
B
C
D
E
F

Bovenweg 29
6721 HV Bennekom

ontwerp
getekend
W. van den Brink

schaal
1:50

formaat
A1

blad
BE-03

tel (0318) 493666
info@degijt.nl
www.degijt.nl

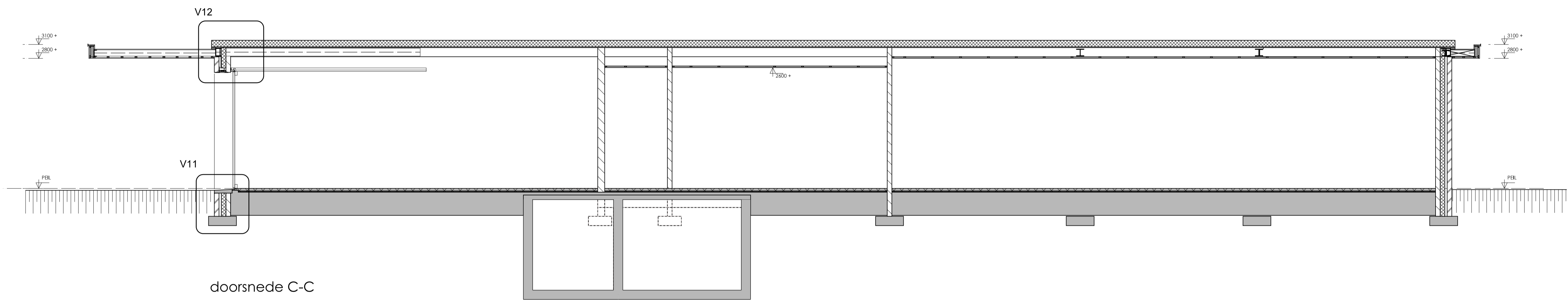

doorsnede C-C

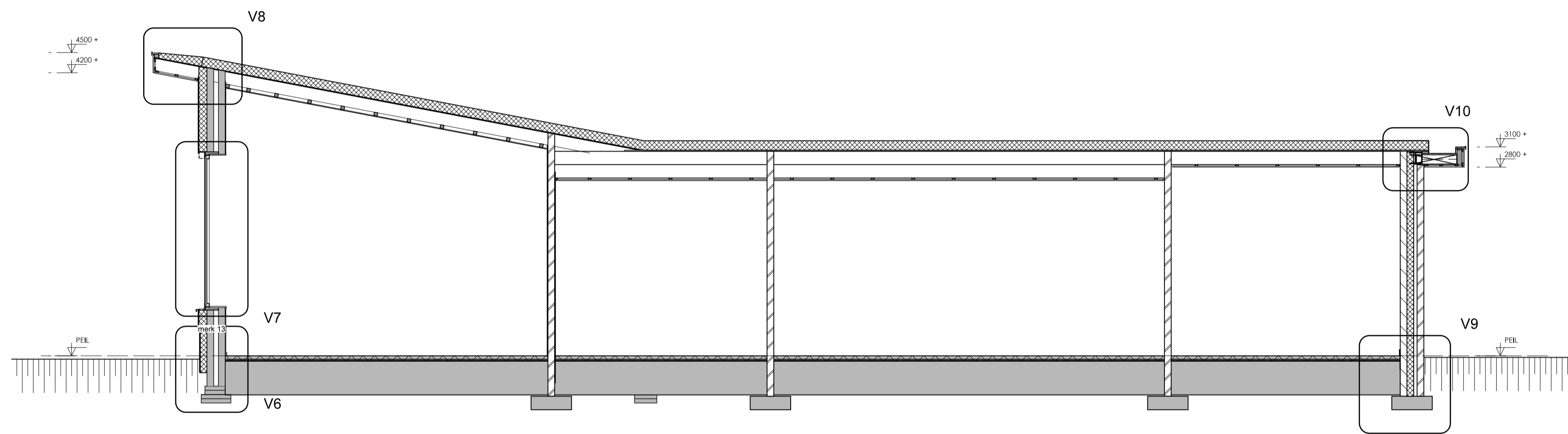

doorsnede A-A

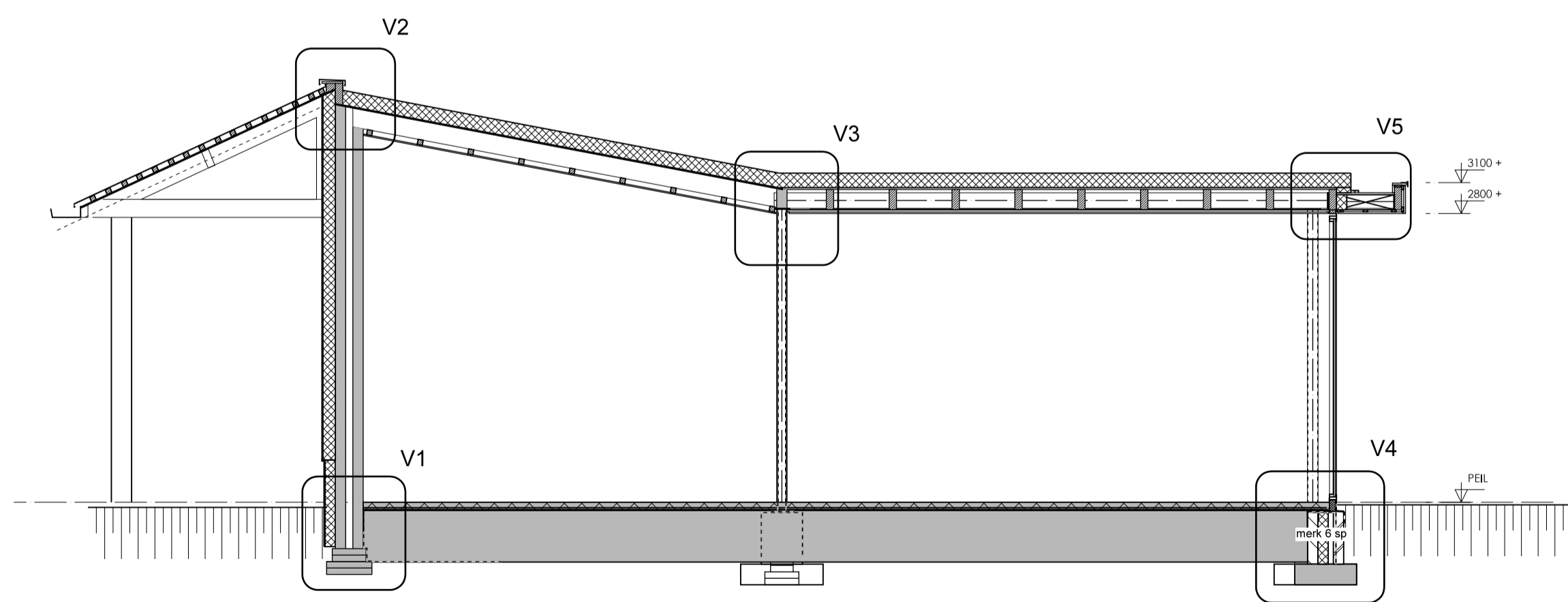

doorsnede B-B

CONCEPT



opdrachtgever
Landheer/Bremmers
project
Verduurzaming woonhuis
onderdeel
doorsneden nieuw



nummer
23055
datum
16-01-2024
gewijzigd
A
B
C
D
E
F
blad
BE-04

Bovenweg 29
6721 HV Bennekom

tel (0318) 493666
info@degijt.nl
www.degijt.nl

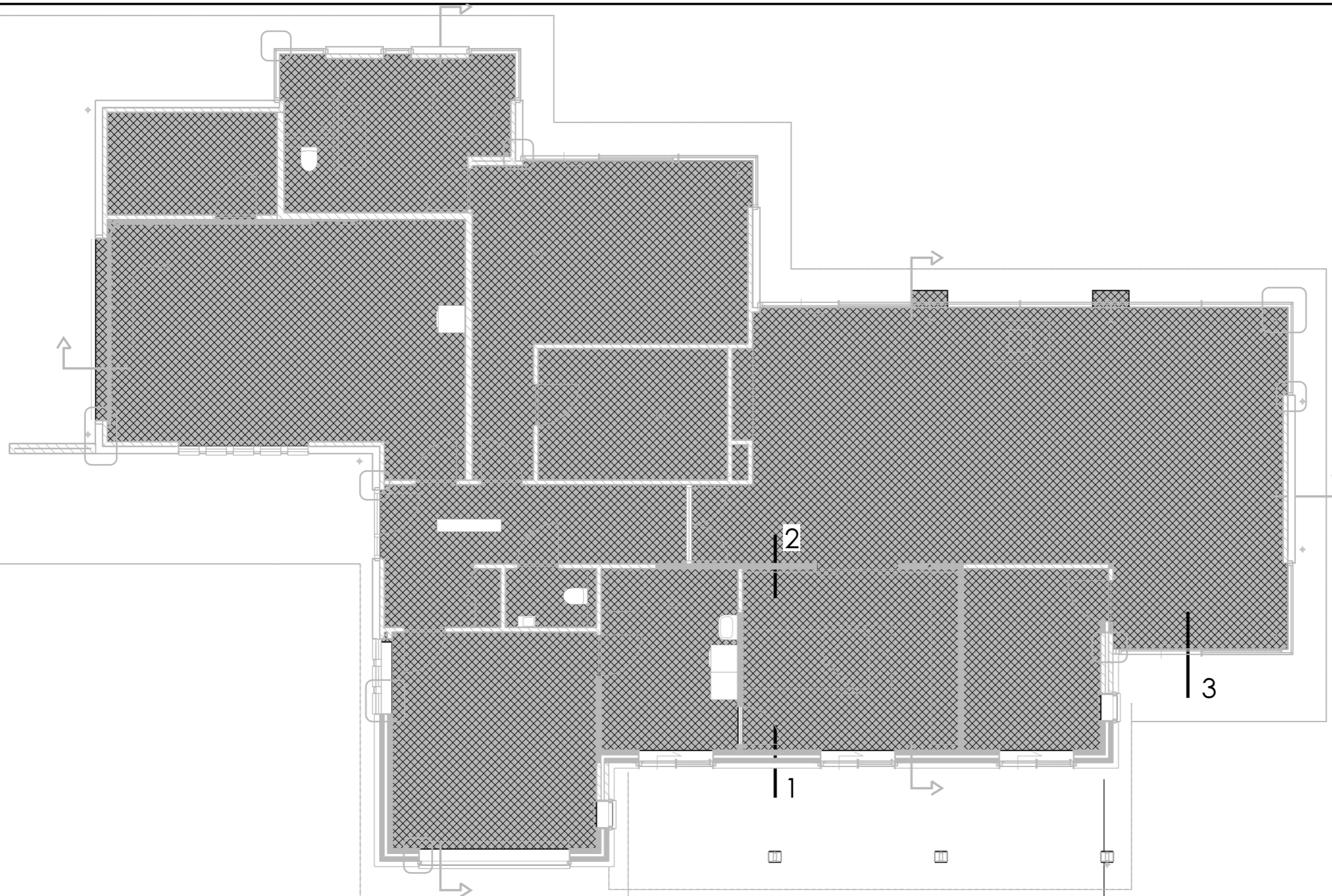
ontwerp
getekend
W. van den Brink
schaal
1:50
formaat
A1

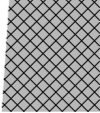

-  bestaande fundering
-  nieuwe fundering volgens opgave constructeur

CONCEPT



principe doorsneden bestaande/nieuwe fundering

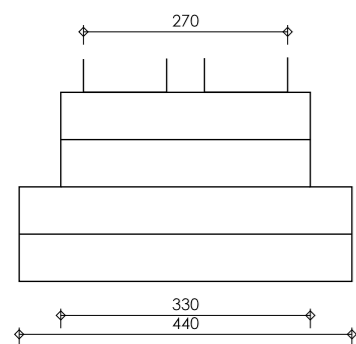

doorsnede 1

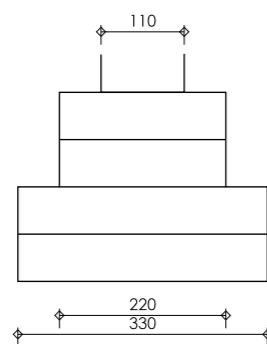

doorsnede 2

doorsnede 3

Bovenweg 29
6721 HV Bennekom

tel (0318) 493666
info@degijt.nl
www.degijt.nl

opdrachtgever
Landheer/Bremmers
project
Verduurzaming woonhuis
onderdeel
fundering bestaand/nieuw

ontwerp

getekend
W. van den Brink

schaal
1:100

formaat
A3

nummer
23055
datum
02-05-2024
gewijzigd
A
B
C
D
E
F

blad
WE-05

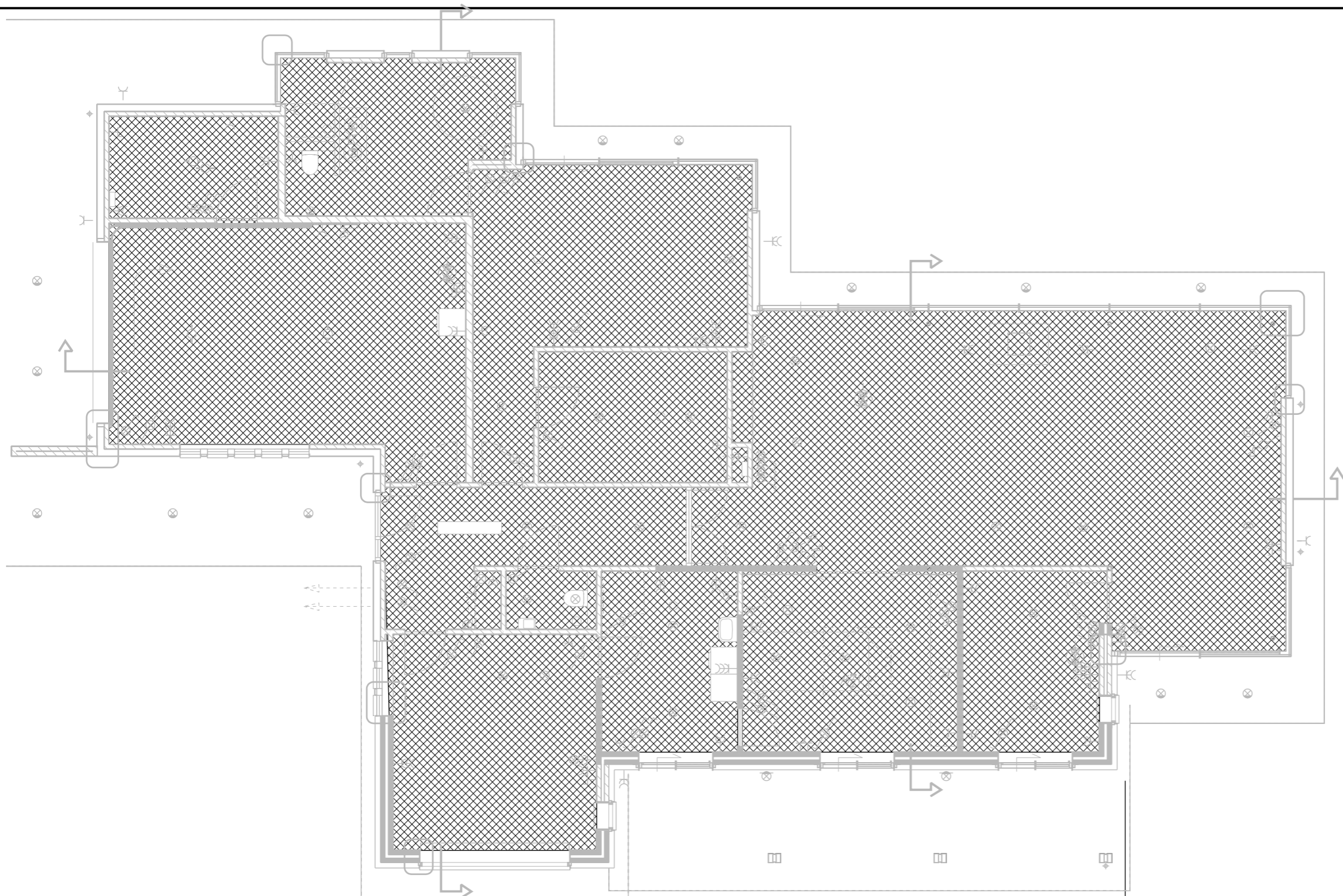

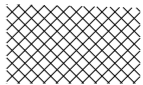
 nieuwe vloerconstr.
 volgens opgave constructeur

CONCEPT

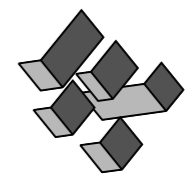

DE GIJT
bouwadviseurs

Bovenweg 29
6721 HV Bennekom

tel (0318) 493666
info@degijt.nl
www.degijt.nl

opdrachtgever
Landheer/Bremmers
project
Verduurzaming woonhuis
onderdeel
vloer nieuw

ontwerp

getekend
W. van den Brink

schaal
1:100

formaat
A3

nummer
23055
datum
02-05-2024
gewijzigd
A
B
C
D
E
F

blad
WE-06

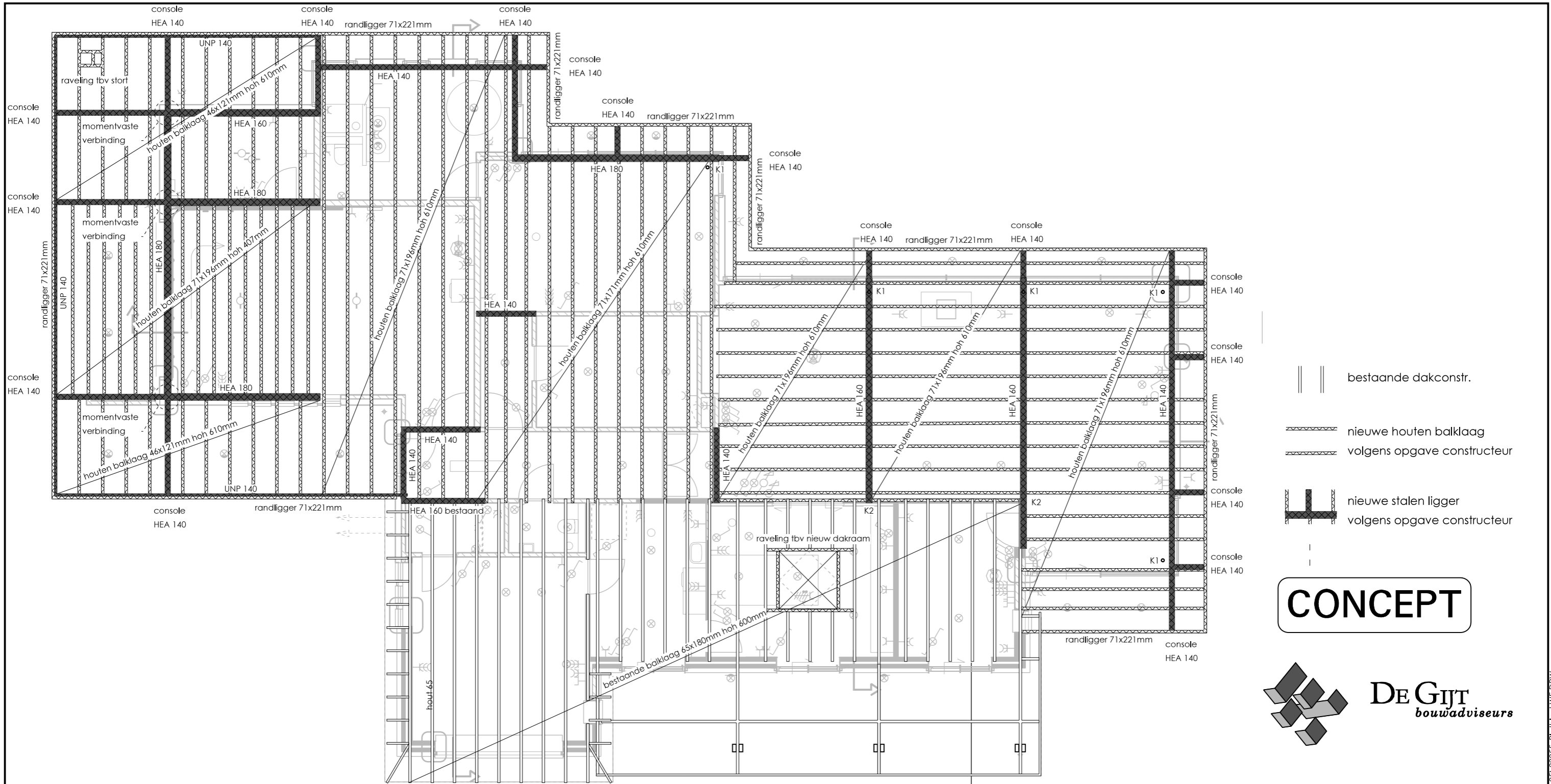

Bovenweg 29
6721 HV Bennekom

tel (0318) 493666
info@degijt.nl
www.degijt.nl

opdrachtgever
Landheer/Bremmers
project
Verduurzaming woonhuis
onderdeel
kap bestaand/nieuw

ontwerp
getekend
W. van den Brink
schaal
1:100
formaat
A3

nummer
23055
datum
02-05-2024
gewijzigd
A
B
C
D
E
F

blad
WE-07

CONCEPT



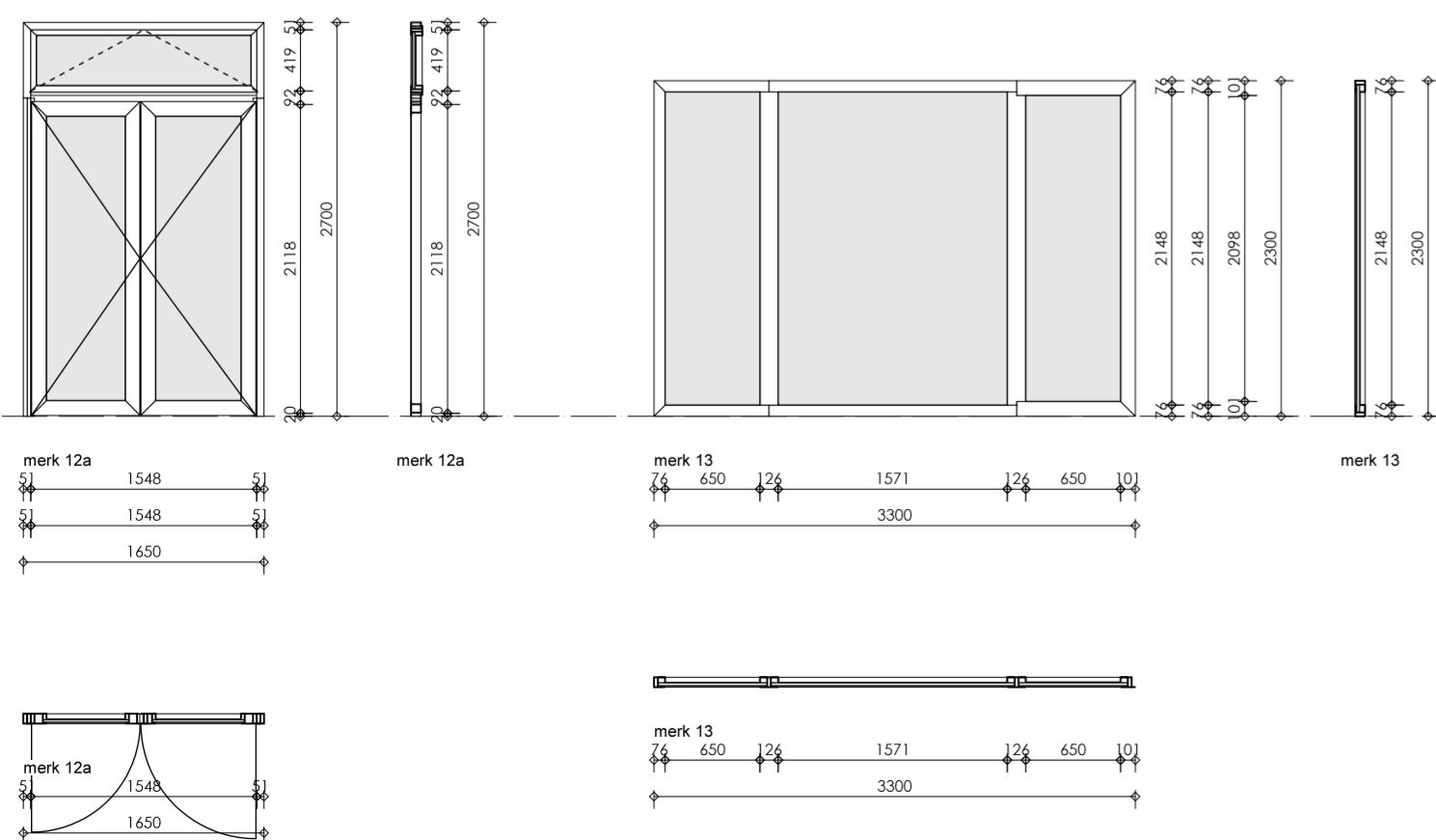
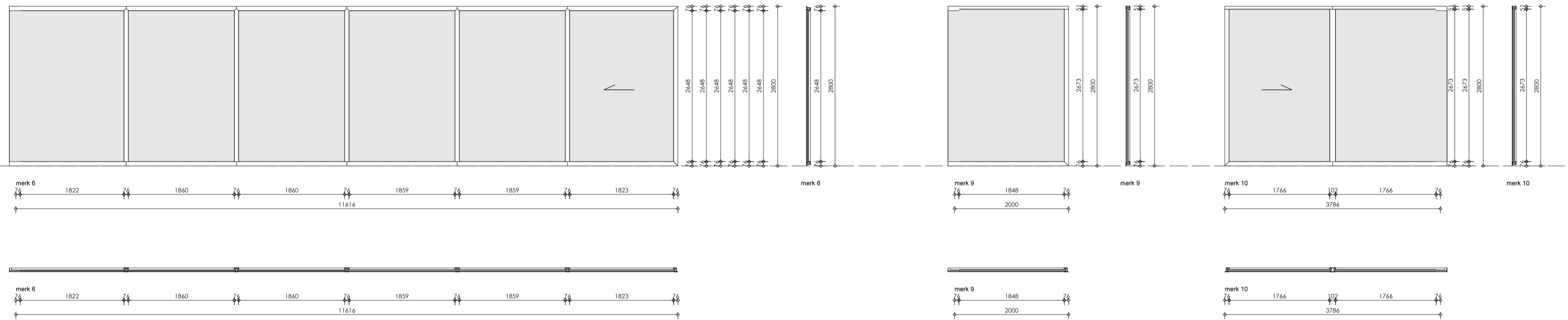
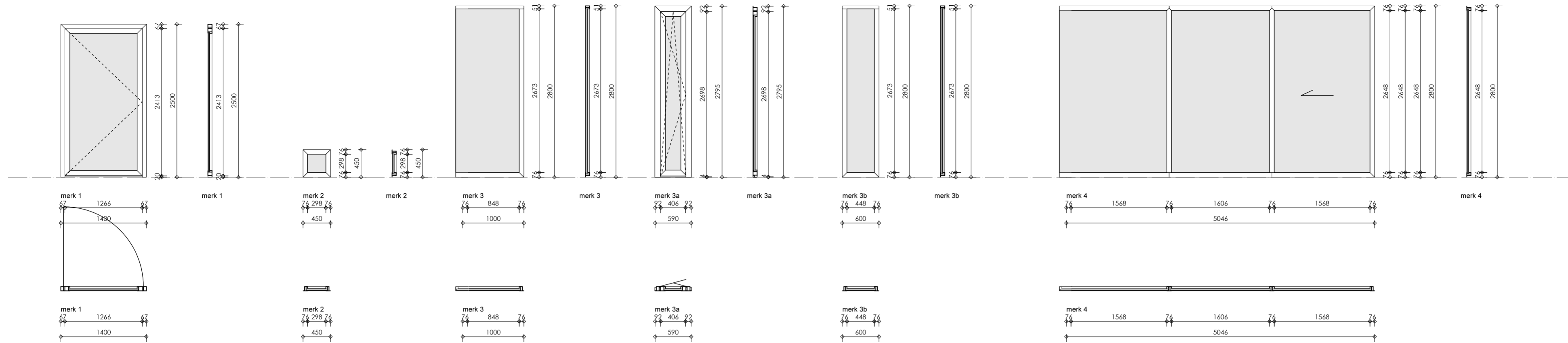

CONCEPT



Bovenweg 29
6721 HV Bennekom

tel (0318) 493666
info@degijt.nl
www.degijt.nl

opdrachtgever
Landheer/Bremmers
project
Verduurzaming woonhuis
onderdeel
Buitenkozijnen

ontwerp
getekend W. van den Brink
schaal 1:100
formaat A2

nummer 23055
datum 16-01-2024
gewijzigd
A
B
C
D
E
F
blad
BE-08

detail nr.	Datum	detail nr.	Datum
H1	16-01-2024		
H2	16-01-2024		
H3	16-01-2024		
H4	16-01-2024		
H5	16-01-2024		
H6	16-01-2024		
H7	16-01-2024		
H8	16-01-2024		
V1	16-01-2024		
V2	16-01-2024		
V3	16-01-2024		
V4	16-01-2024		
V5	16-01-2024		
V6	16-01-2024		
V7	16-01-2024		
V8	16-01-2024		
V9	16-01-2024		
V10	16-01-2024		
V11	16-01-2024		
V12	16-01-2024		

Bovenweg 29
6721 HV Bennekom

tel (0318) 493666
info@degijt.nl
www.degijt.nl

opdrachtgever
Landheer/Bremmers
project
Verduurzaming woonhuis
onderdeel
details

ontwerp

getekend
W. van den Brink

schaal
1:5

formaat
A3

nummer
23055
datum
16-01-2024
gewijzigd
A
B
C
D
E
F

blad
BE-09

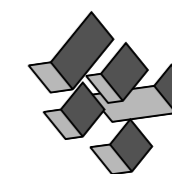

DE GIJT
bouwadviseurs

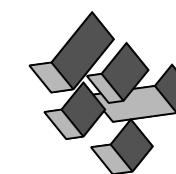
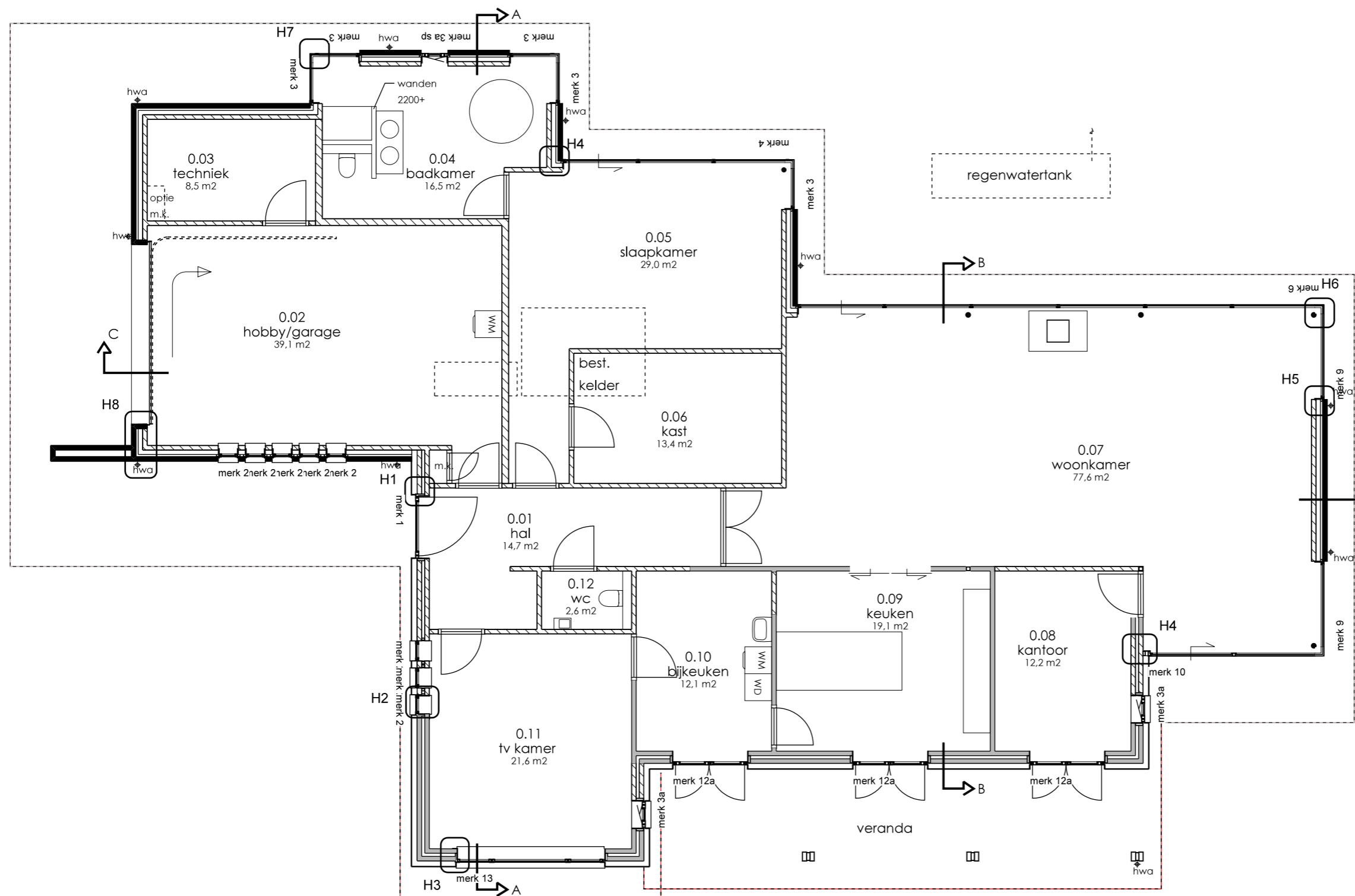

schaal
 1:5
 datum
 16-01-2024
 gewijzigd
 A
 B
 C
 D
 E
 F
 detail
HOR

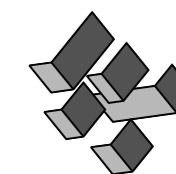
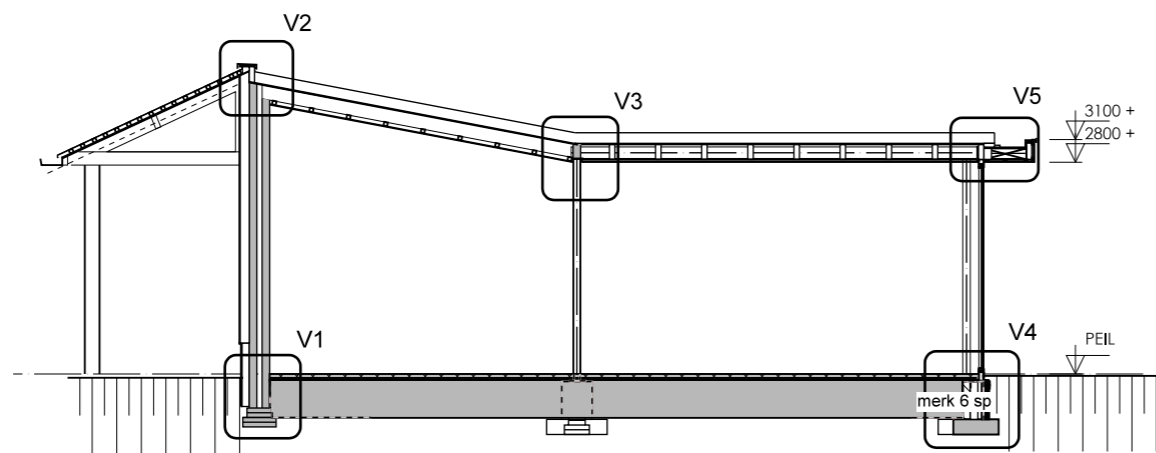
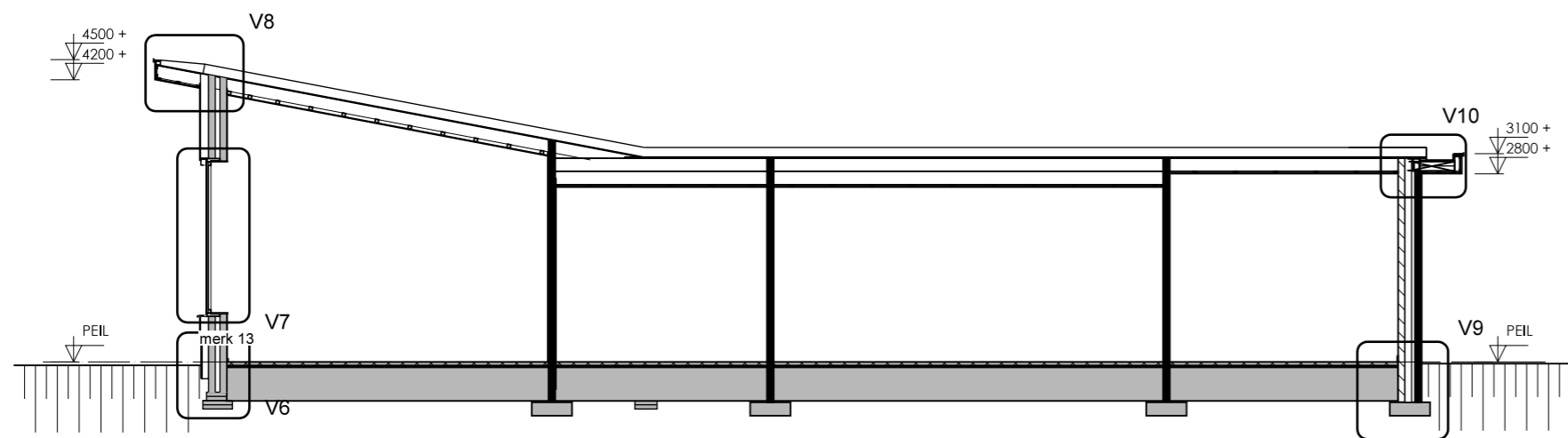
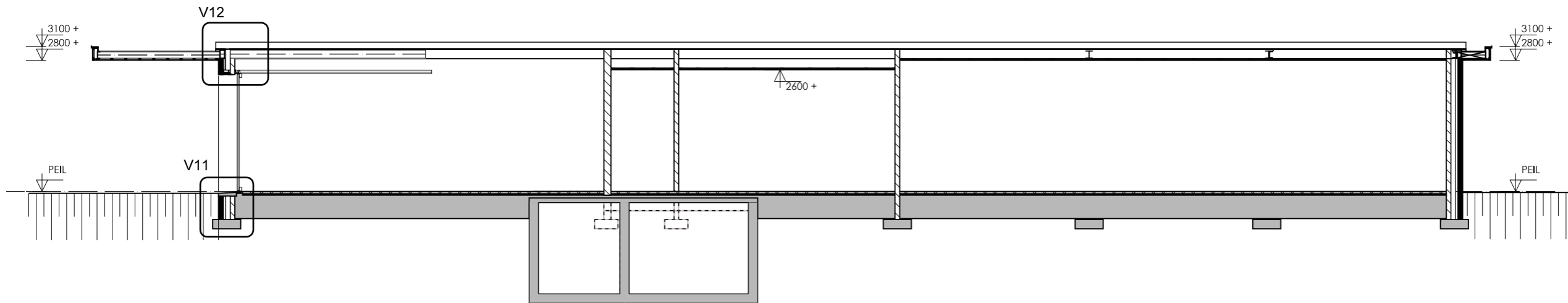

schaal
 1:5
 datum
 16-01-2024
 gewijzigd
 A
 B
 C
 D
 E
 F
 detail
VER

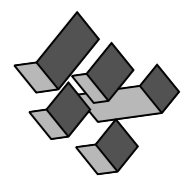
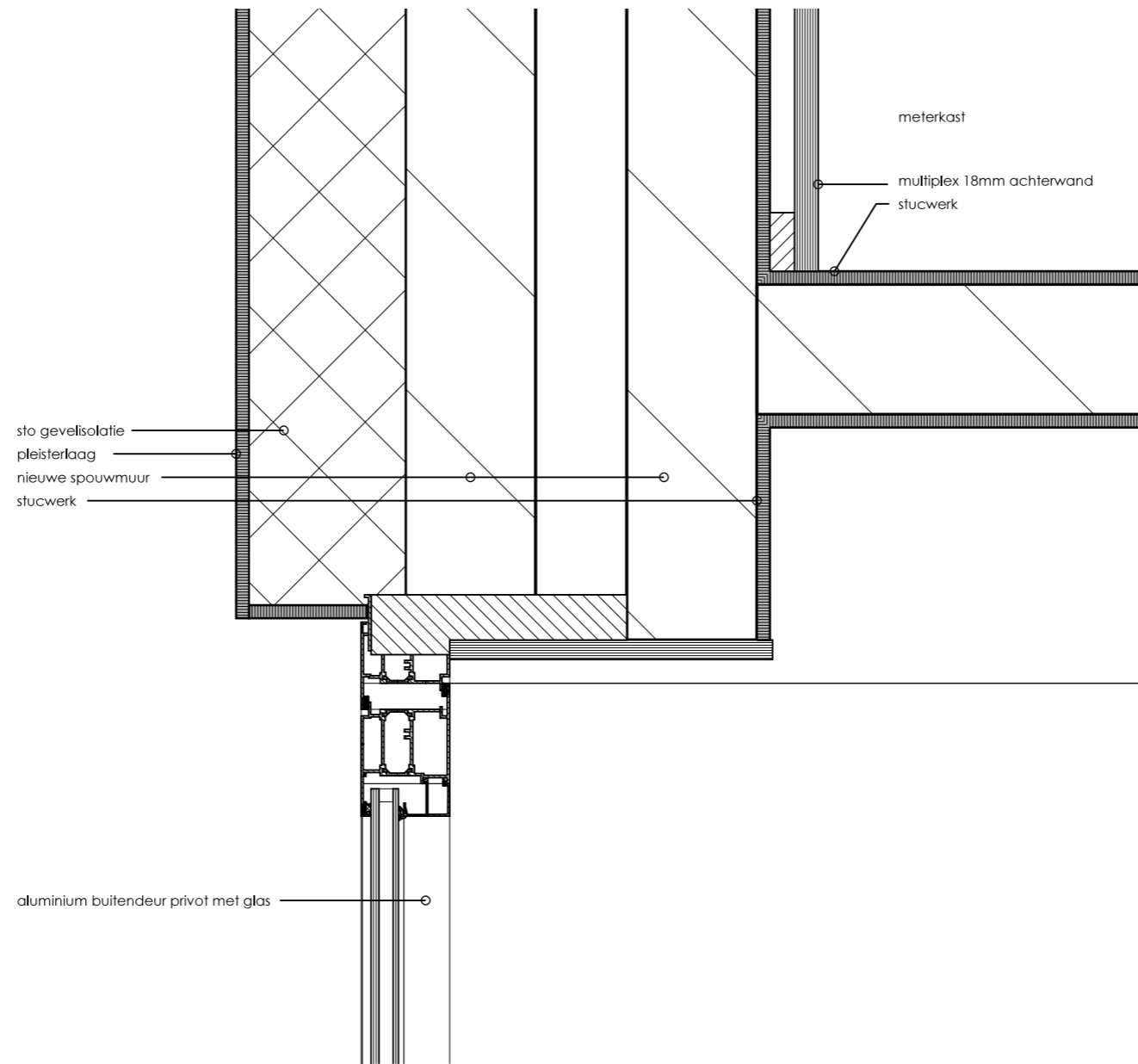

schaal
 1:5
 datum
 16-01-2024
 gewijzigd
 A
 B
 C
 D
 E
 F
 detail
H1

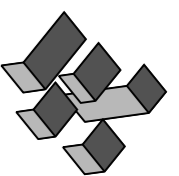
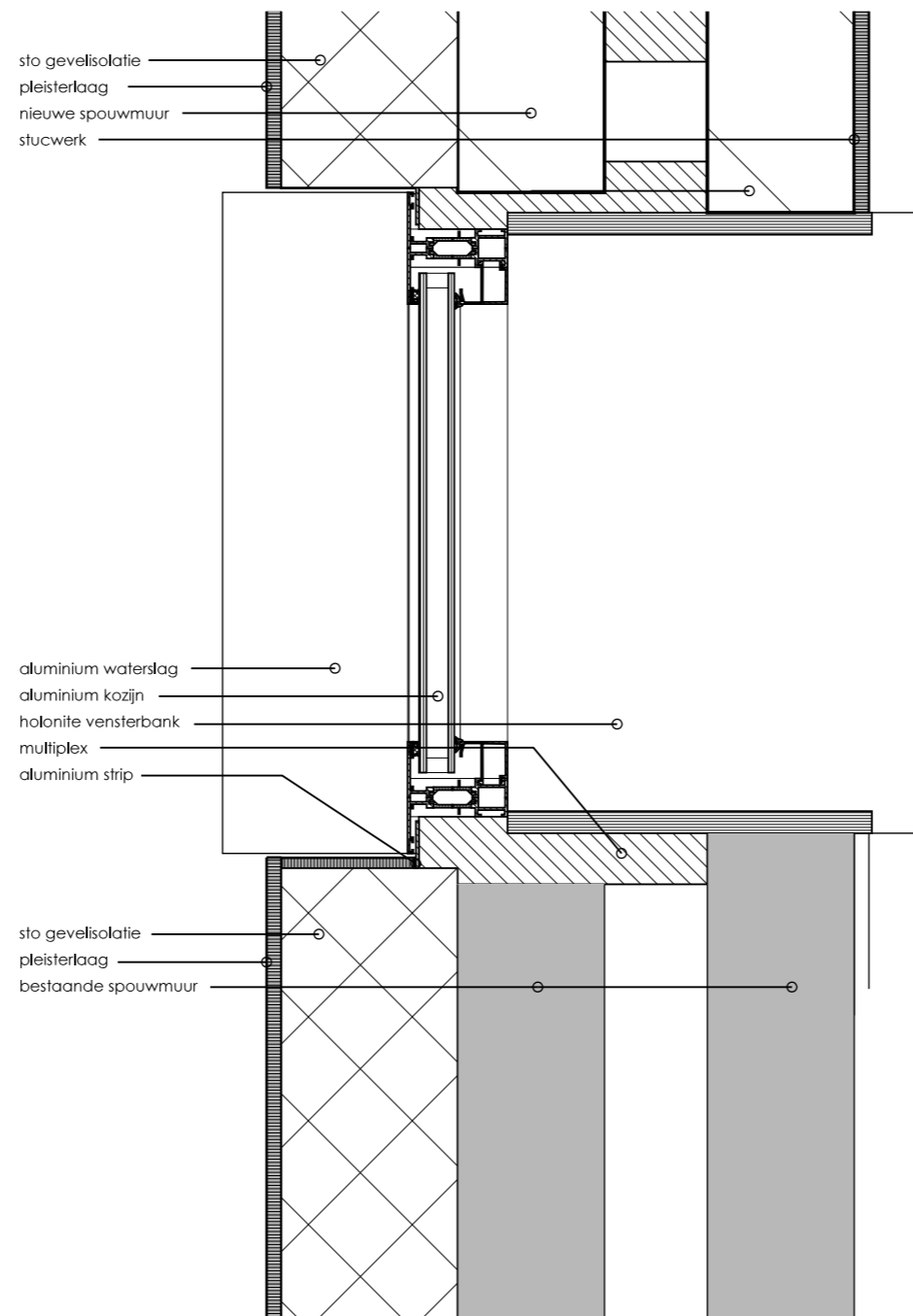

schaal
 1:5
 datum
 16-01-2024
 gewijzigd
 A
 B
 C
 D
 E
 F
 detail
H2

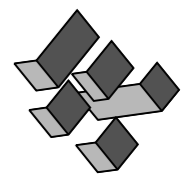
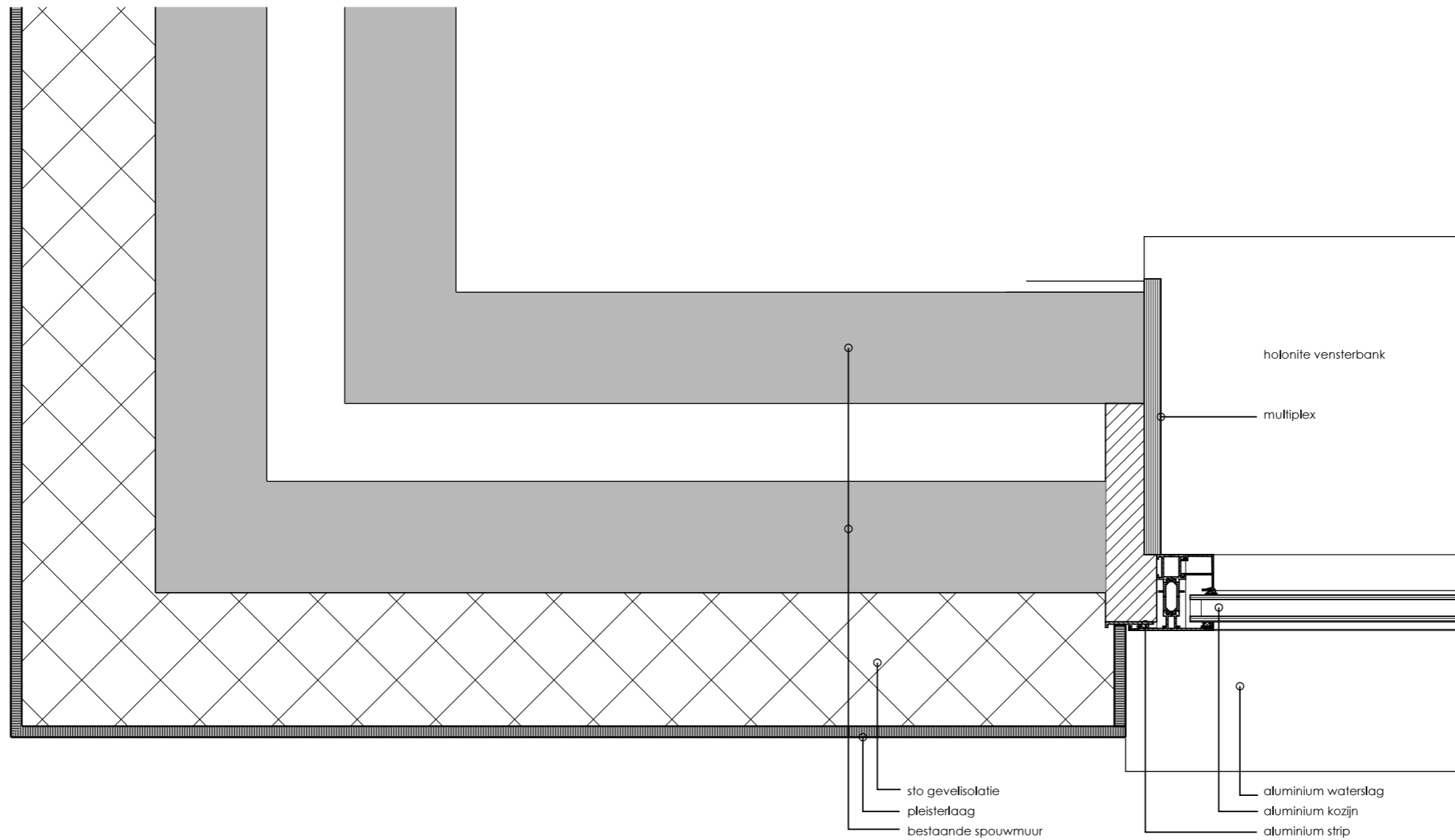

schaal
 1:5
 datum
 16-01-2024
 gewijzigd
 A
 B
 C
 D
 E
 F
 detail
H3

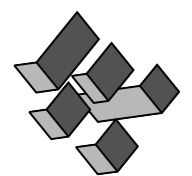
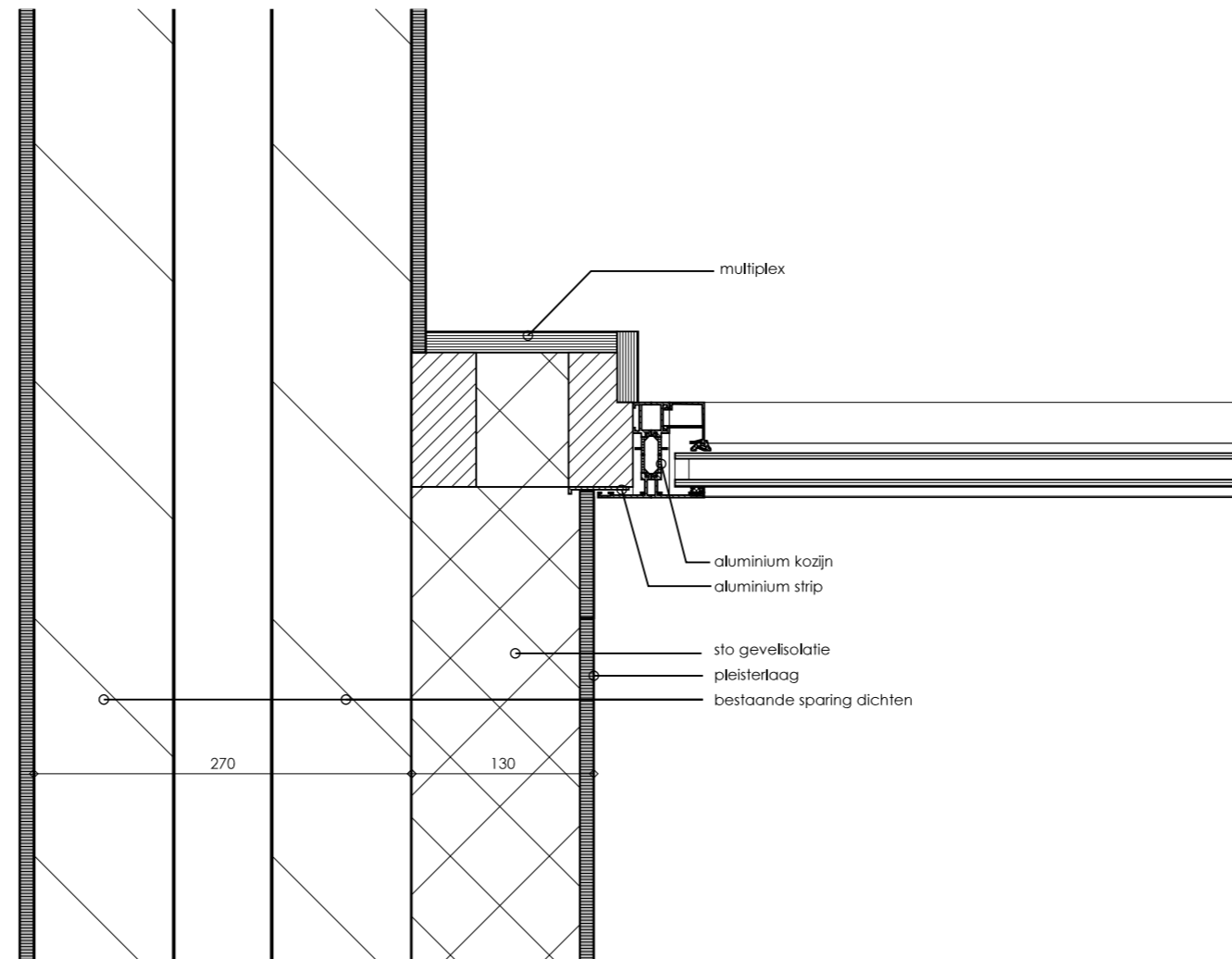

schaal
 1:5
 datum
 16-01-2024
 gewijzigd
 A
 B
 C
 D
 E
 F
 detail
H4

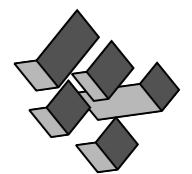
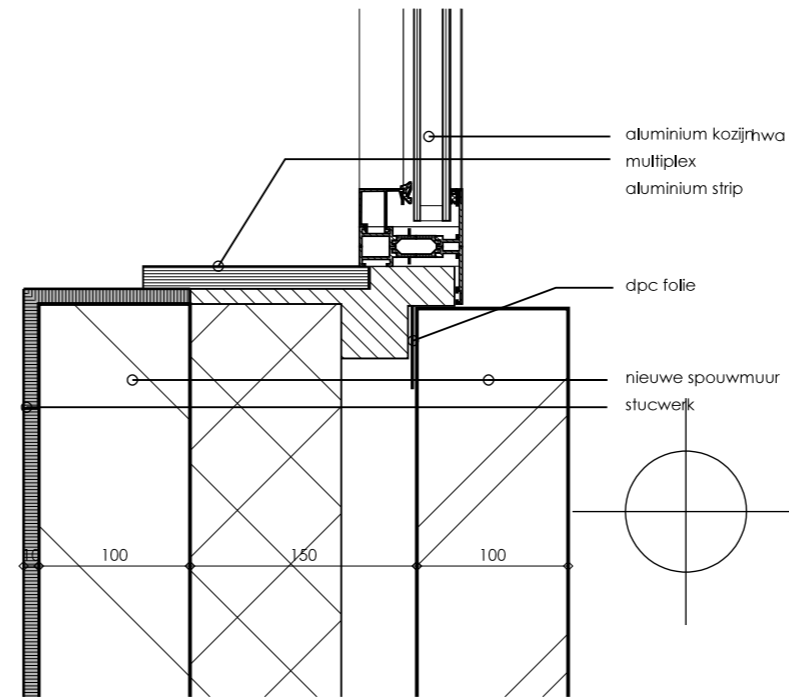

schaal
1:5
datum
16-01-2024
gewijzigd
A
B
C
D
E
F
detail
H5

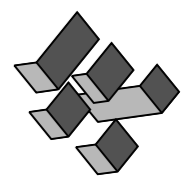
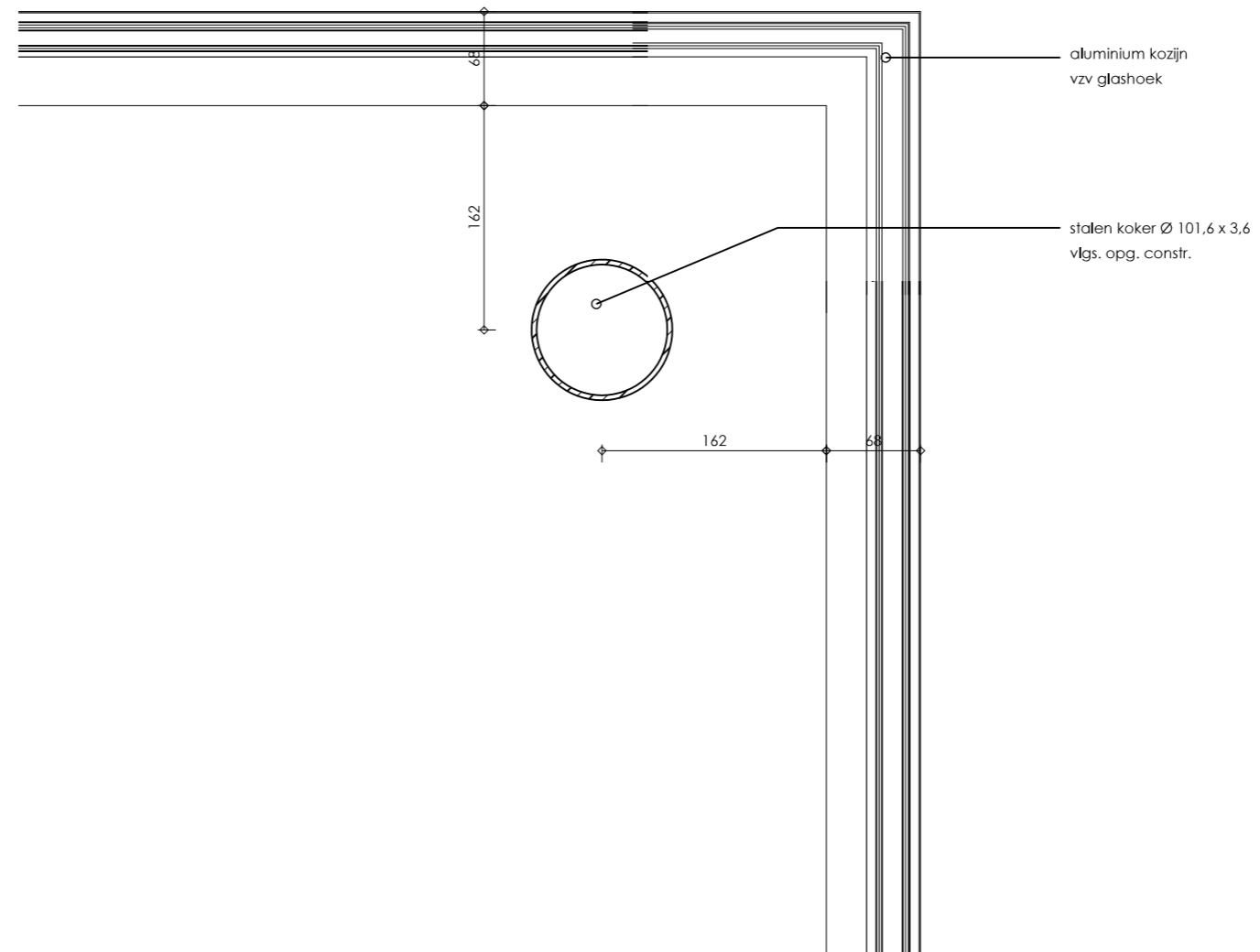

schaal
1:5
datum
16-01-2024
gewijzigd
A
B
C
D
E
F
detail
H6

aluminium kozijn
vzv glashoek

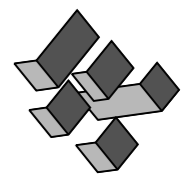
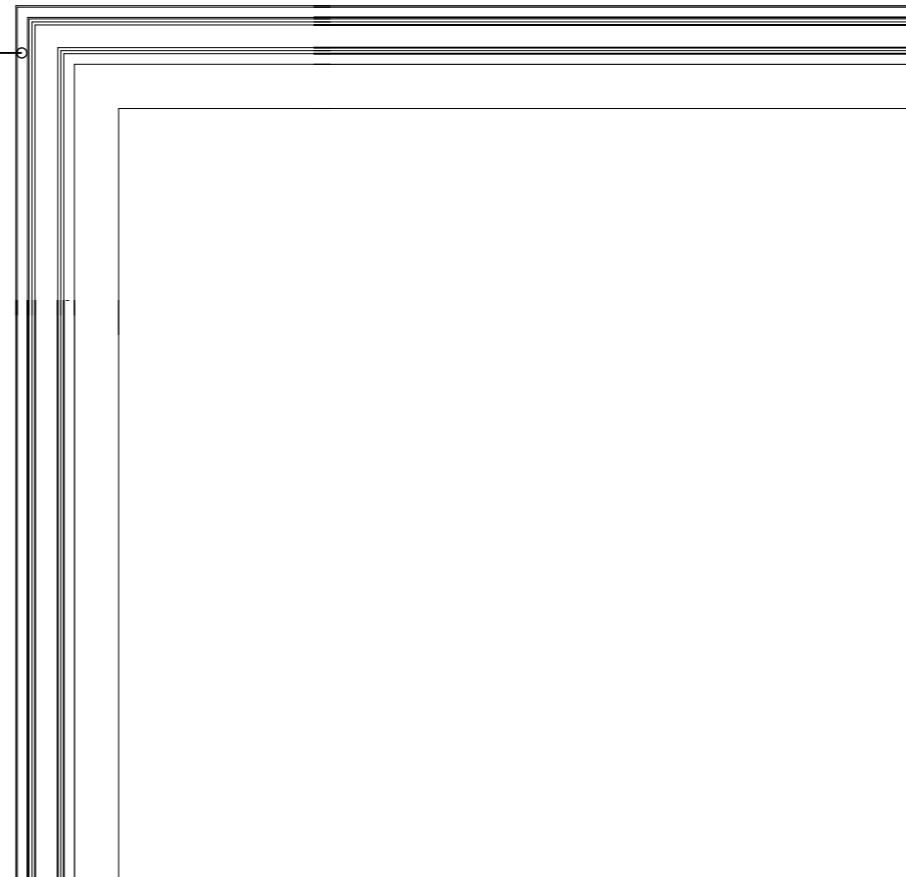

schaal
1:5
datum
16-01-2024
gewijzigd
A
B
C
D
E
F
detail
H7

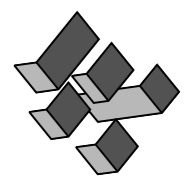
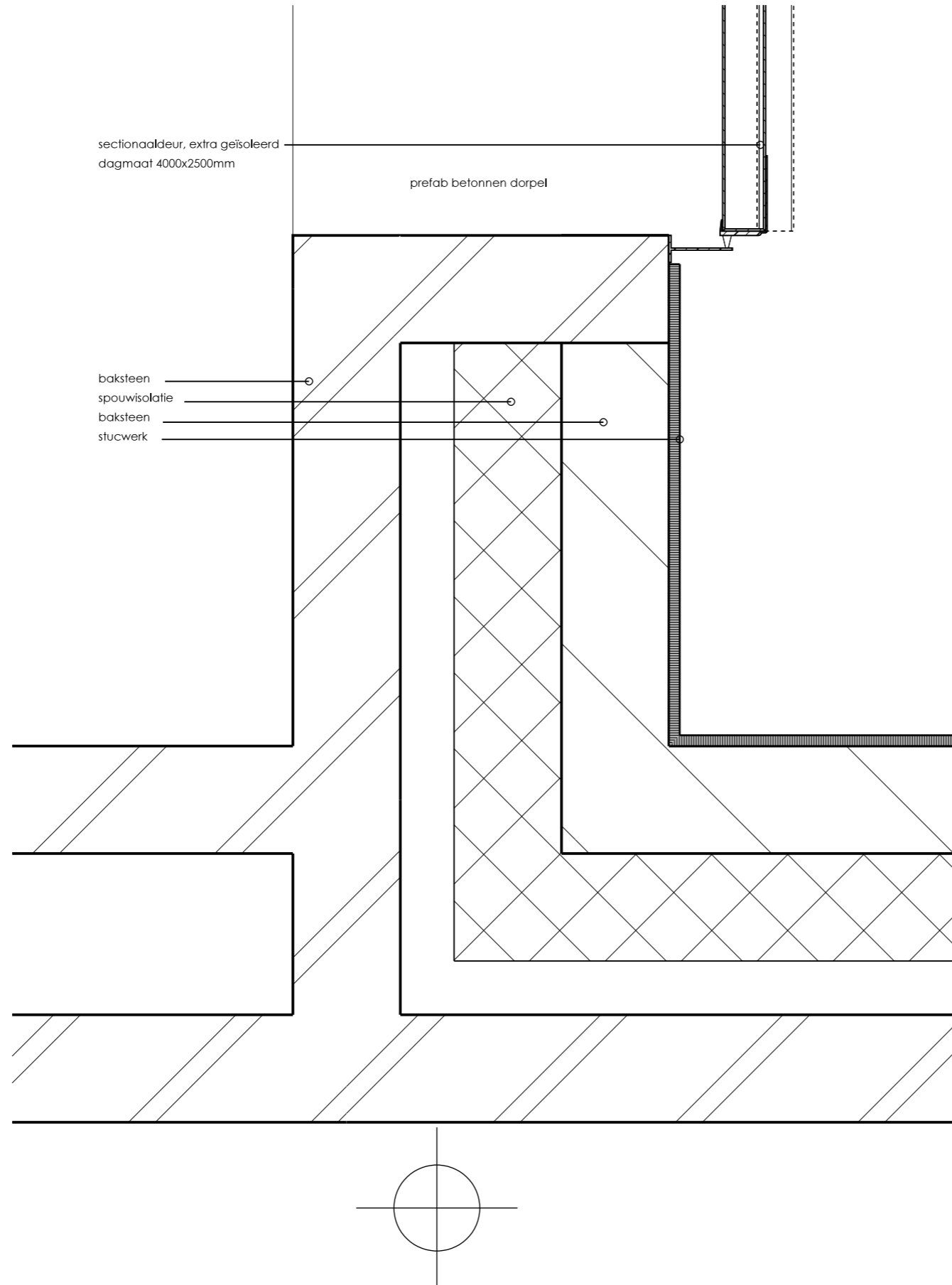

schaal
 1:5
 datum
 16-01-2024
 gewijzigd
 A
 B
 C
 D
 E
 F
 detail
H8

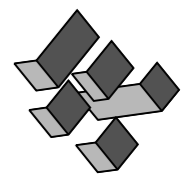
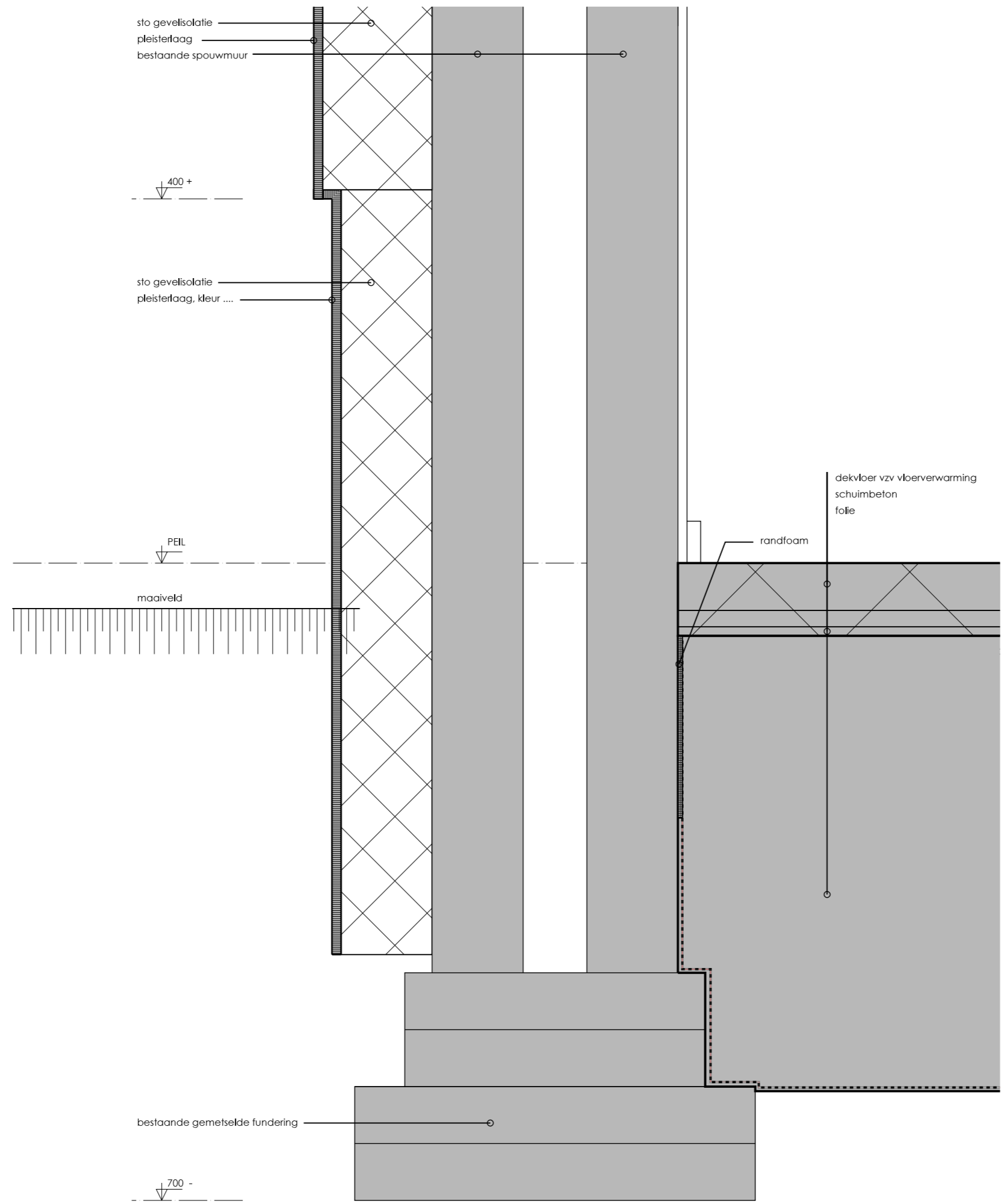

schaal
 1:5
 datum
 16-01-2024
 gewijzigd
 A
 B
 C
 D
 E
 F
 detail
V1

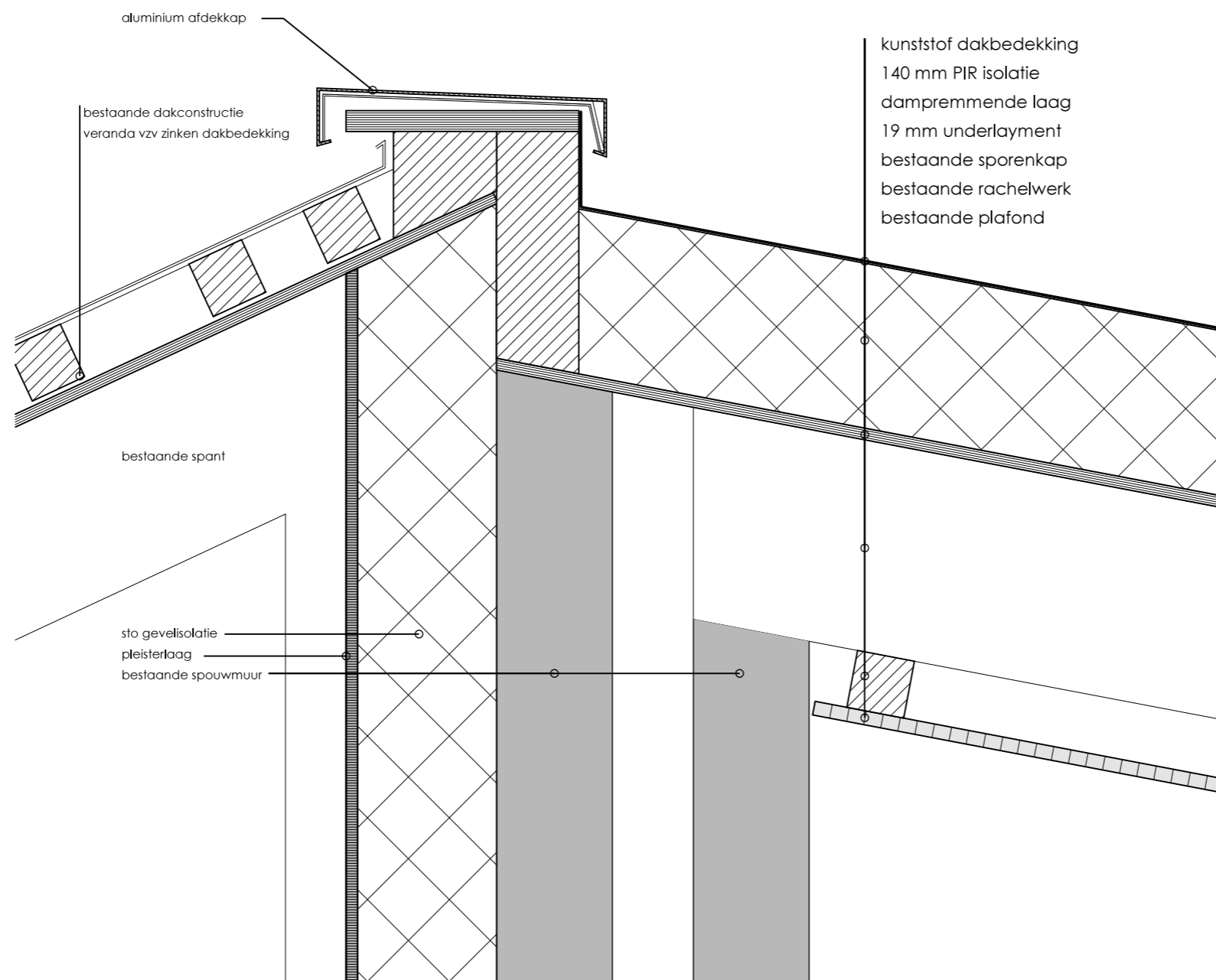

aluminium afdekkap

bestaande dakconstructie
veranda vzw zinken dakbedekking

kunststof dakbedekking
140 mm PIR isolatie
dampremmende laag
19 mm underlayment
bestaande sporenkap
bestaande rachelwerk
bestaande plafond

bestaande spant

sto gevelisolatie
pleisterlaag
bestaande spouwmuur

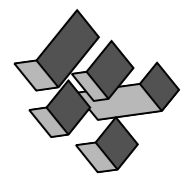

schaal
 1:5
 datum
 16-01-2024
 gewijzigd
 A
 B
 C
 D
 E
 F
 detail
V2

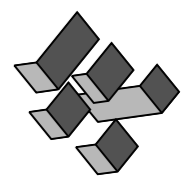
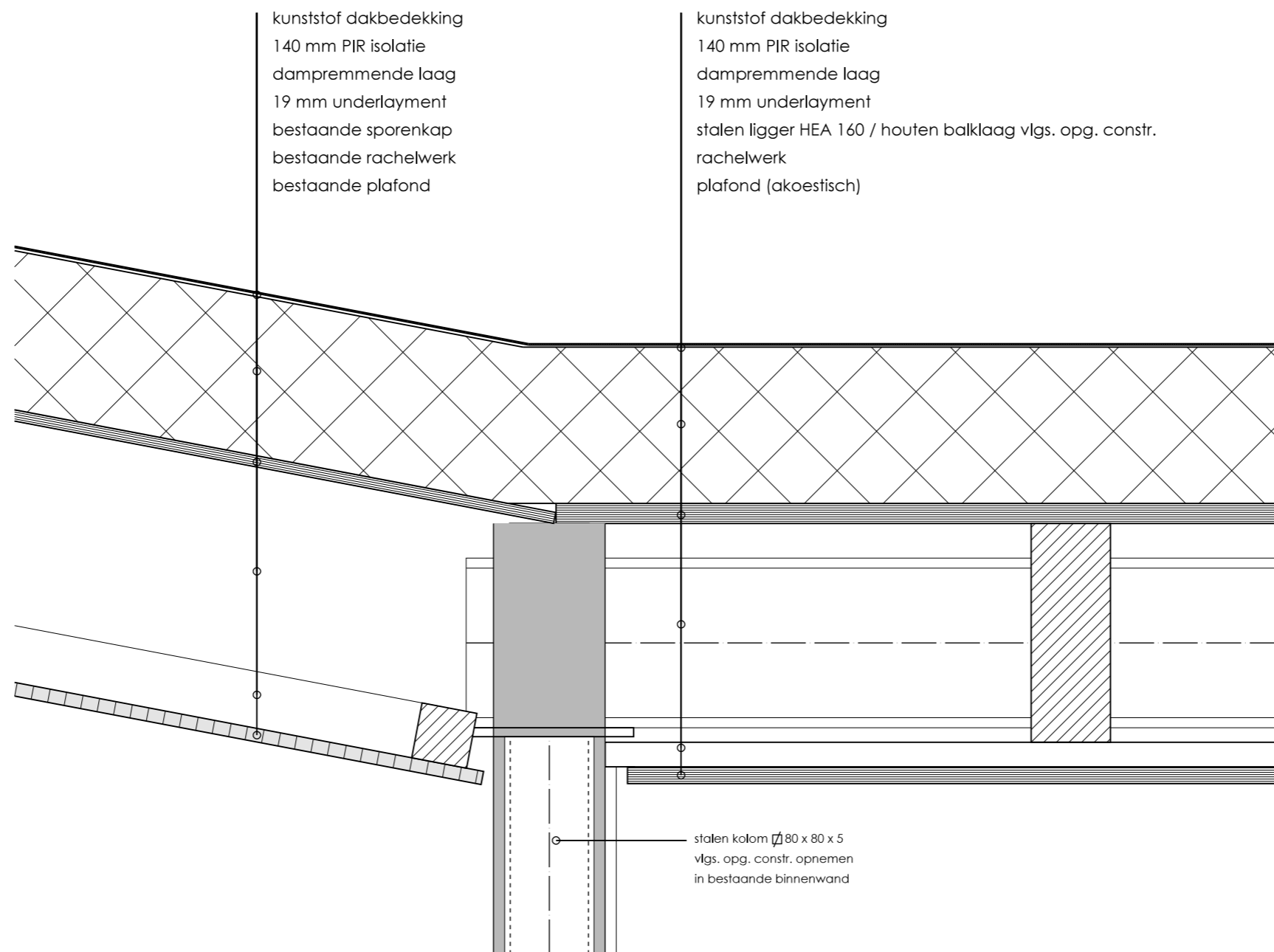

schaal
 1:5
 datum
 16-01-2024
 gewijzigd
 A
 B
 C
 D
 E
 F
 detail
V3

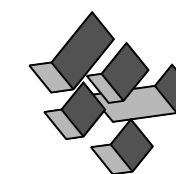
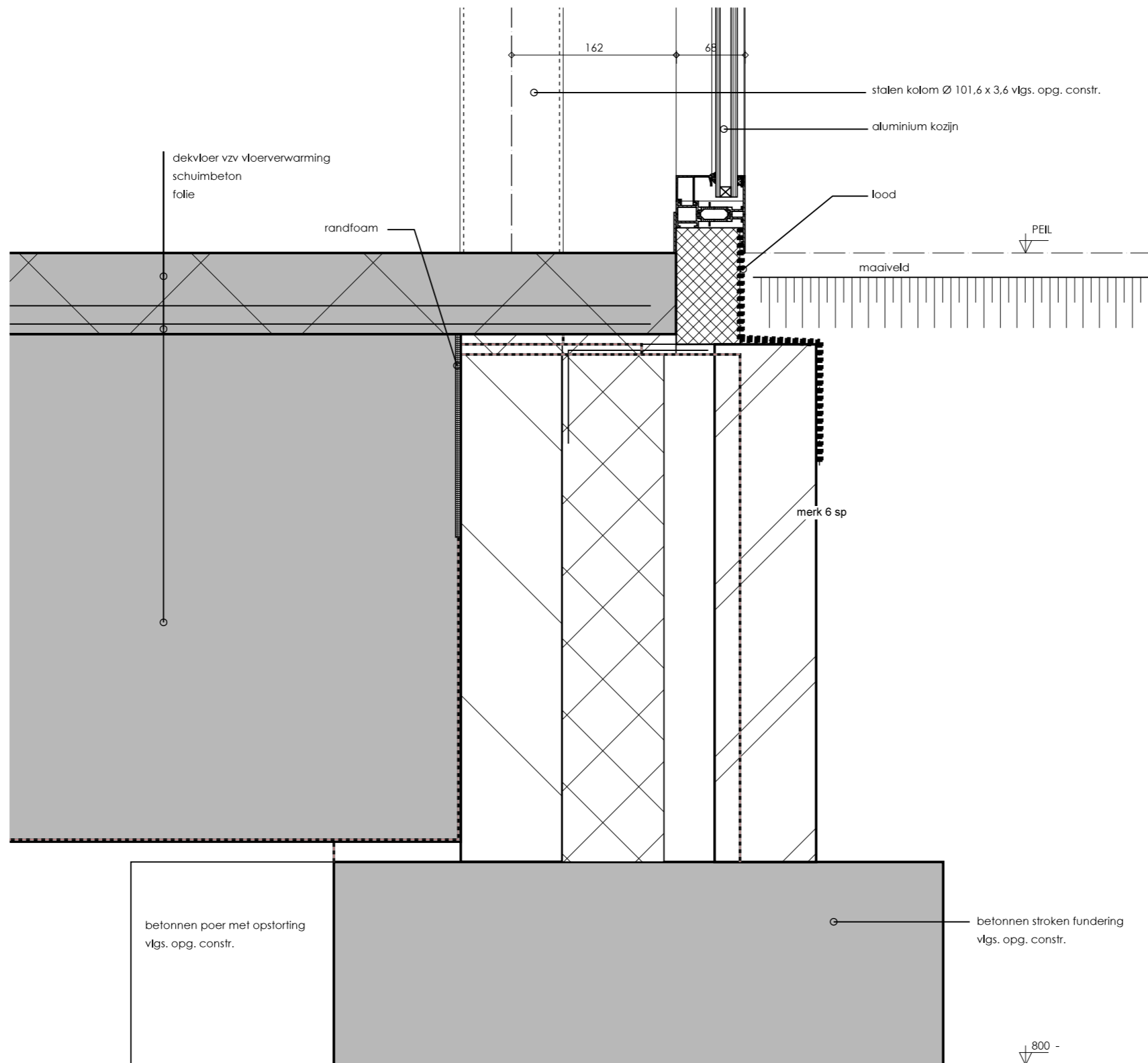

schaal
 1:5
 datum
 16-01-2024
 gewijzigd
 A
 B
 C
 D
 E
 F
 detail
V4

kunststof dakbedekking
 140 mm PIR isolatie
 dampremmende laag
 19 mm underlayment
 stalen ligger HEA 160 / houten balklaag vlg. opg. constr.
 rachelwerk
 plafond (akoestisch)

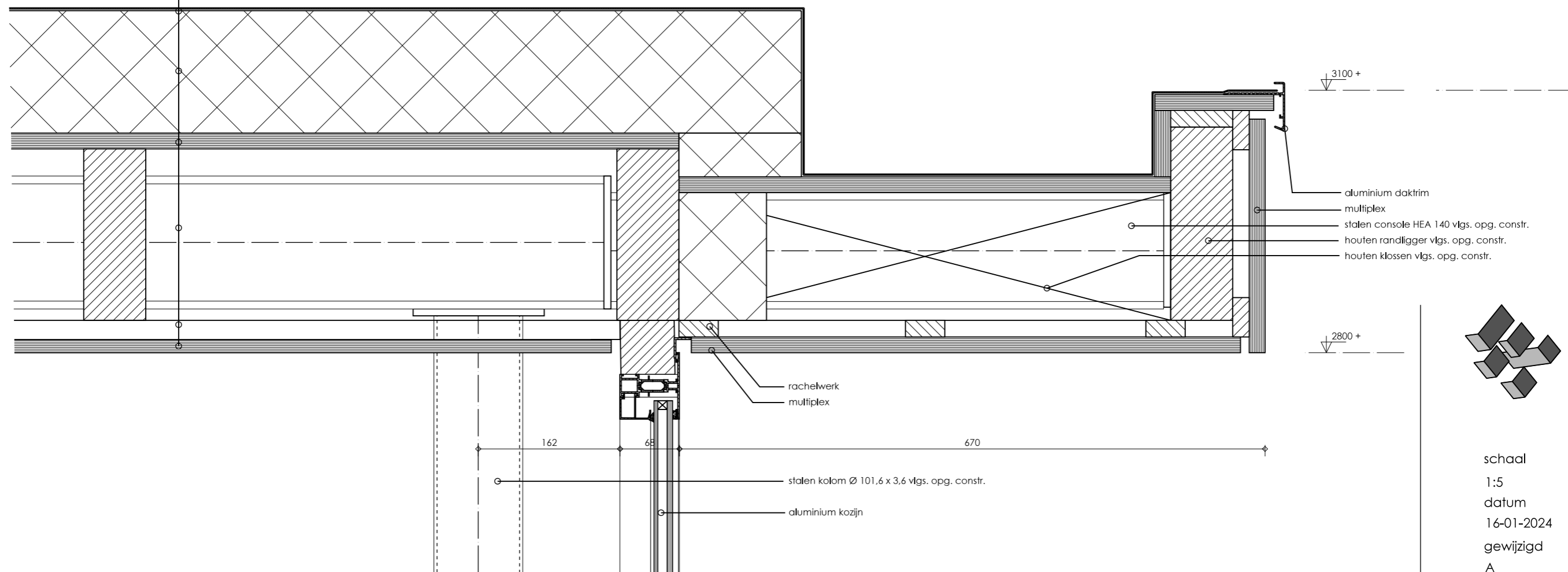

aluminium daktrim
 multiplex
 stalen console HEA 140 vlg. opg. constr.
 houten randligger vlg. opg. constr.
 houten klossen vlg. opg. constr.

rachelwerk
 multiplex

162 68 670
 stalen kolom Ø 101,6 x 3,6 vlg. opg. constr.
 aluminium kozijn

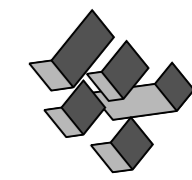

schaal
 1:5
 datum
 16-01-2024
 gewijzigd
 A
 B
 C
 D
 E
 F
 detail
V5

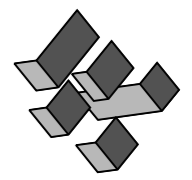
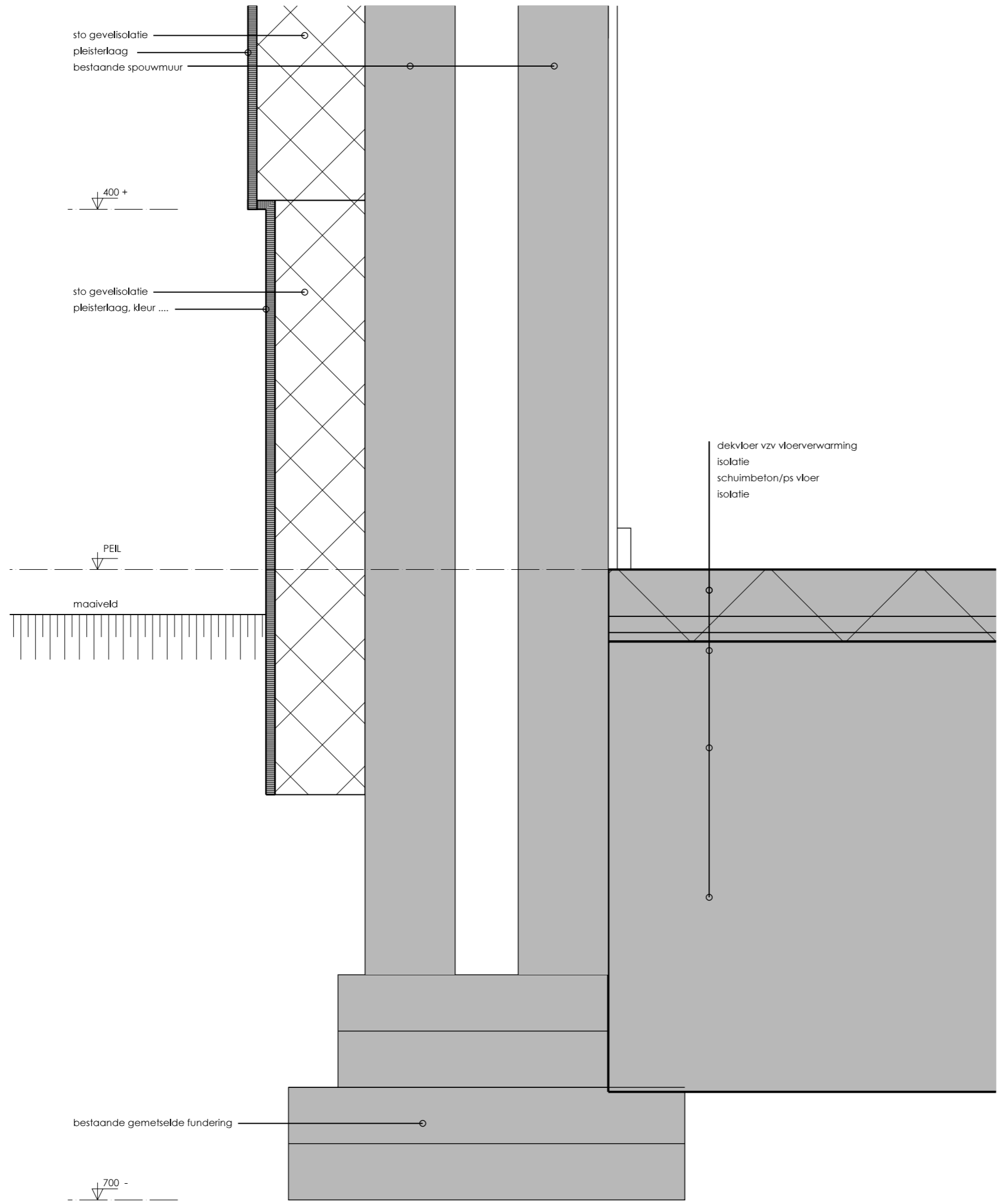

schaal
 1:5
 datum
 16-01-2024
 gewijzigd
 A
 B
 C
 D
 E
 F
 detail
V6

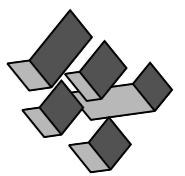
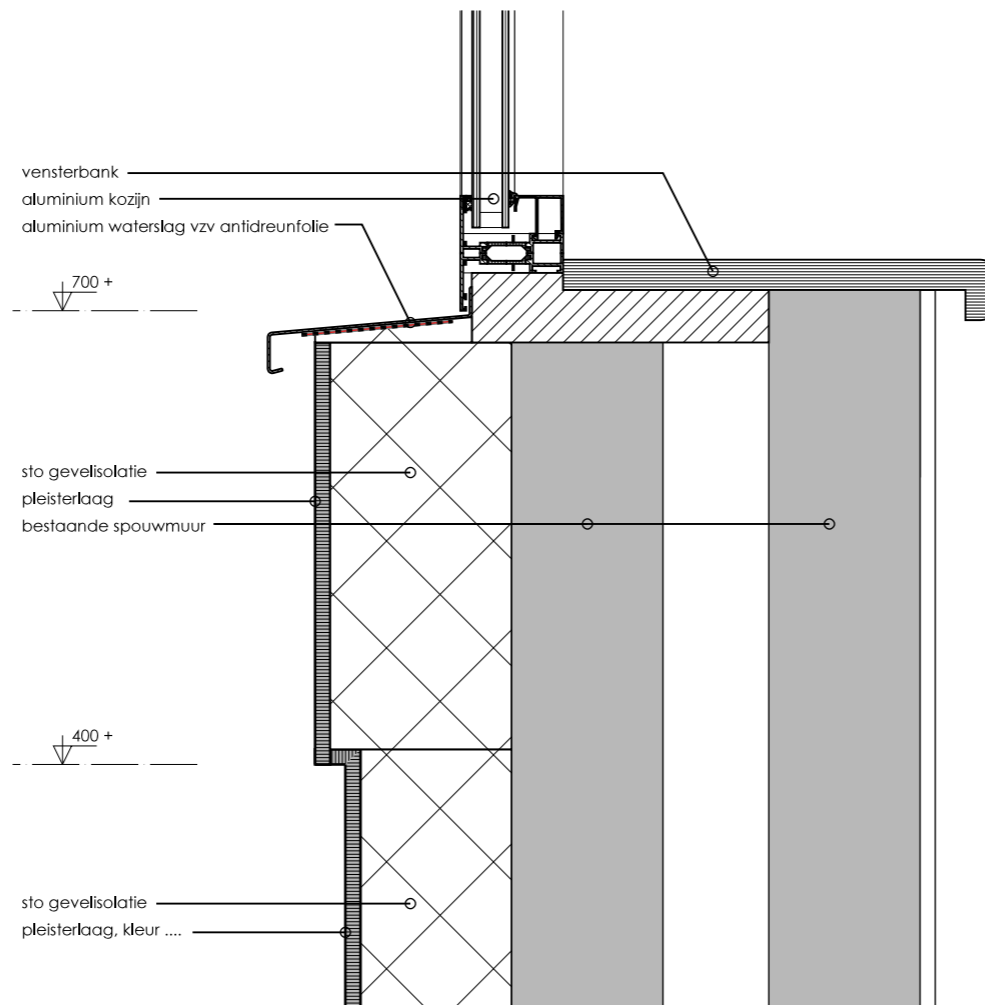
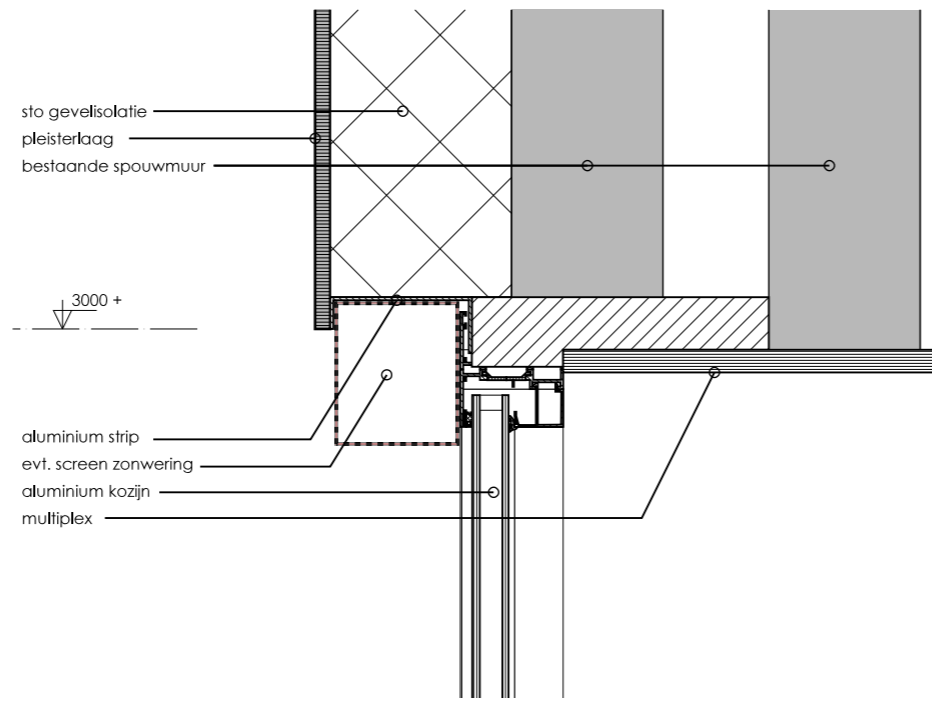

schaal
 1:5
 datum
 16-01-2024
 gewijzigd
 A
 B
 C
 D
 E
 F
 detail
V7

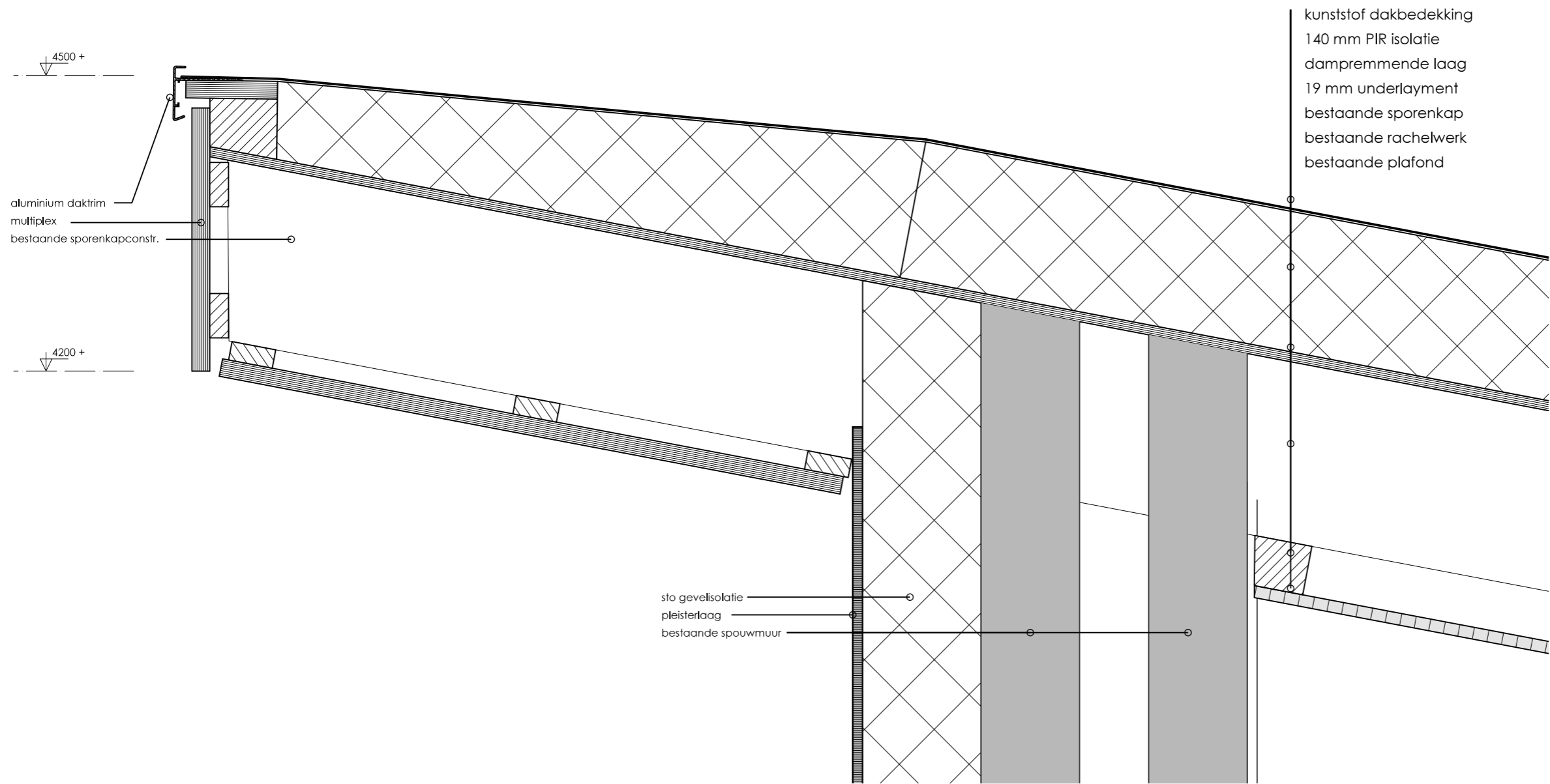

4500 +

4200 +

aluminium daktrim
multiplex
bestaande sporenkapconstr.

kunststof dakbedekking
140 mm PIR isolatie
dampremmende laag
19 mm underlayment
bestaande sporenkap
bestaande rachelwerk
bestaande plafond

sto gevelisolatie
pleisterlaag
bestaande spouwmuur

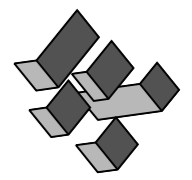

schaal
 1:5
 datum
 16-01-2024
 gewijzigd
 A
 B
 C
 D
 E
 F
 detail
V8

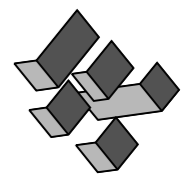
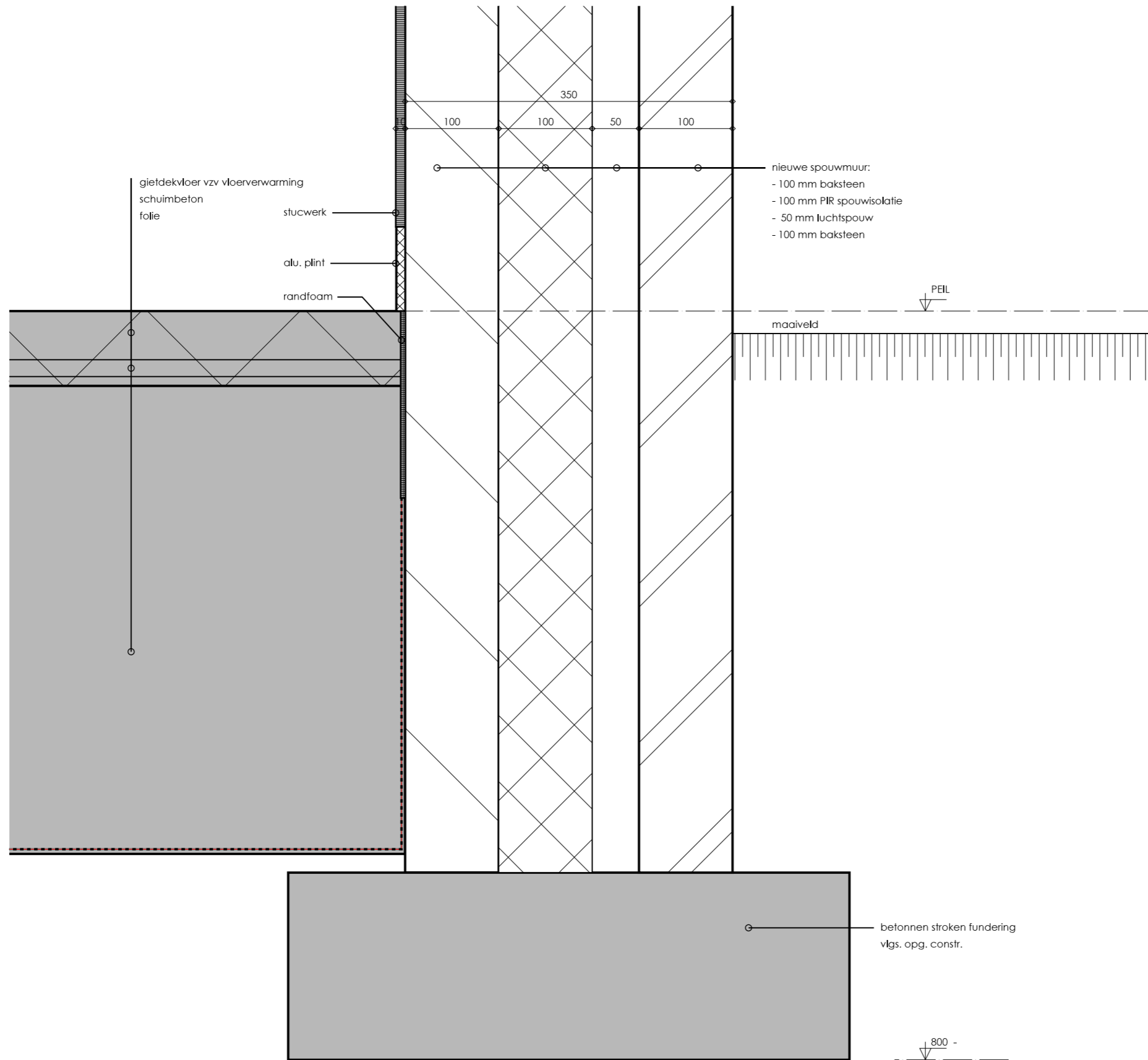

schaal
 1:5
 datum
 16-01-2024
 gewijzigd
 A
 B
 C
 D
 E
 F
 detail
V9

bestandsnaam: F:\PROJECT\UH-Be-Dw\23055 Dikkenbergweg 25\23055_Plotblad A3 - BE.DRW

kunststof dakbedekking
 140 mm PIR isolatie
 dampremmende laag
 19 mm underlayment
 houten balklaag vlg. opg. constr.
 rachelwerk
 plafond (akoestisch)

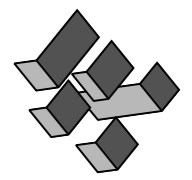
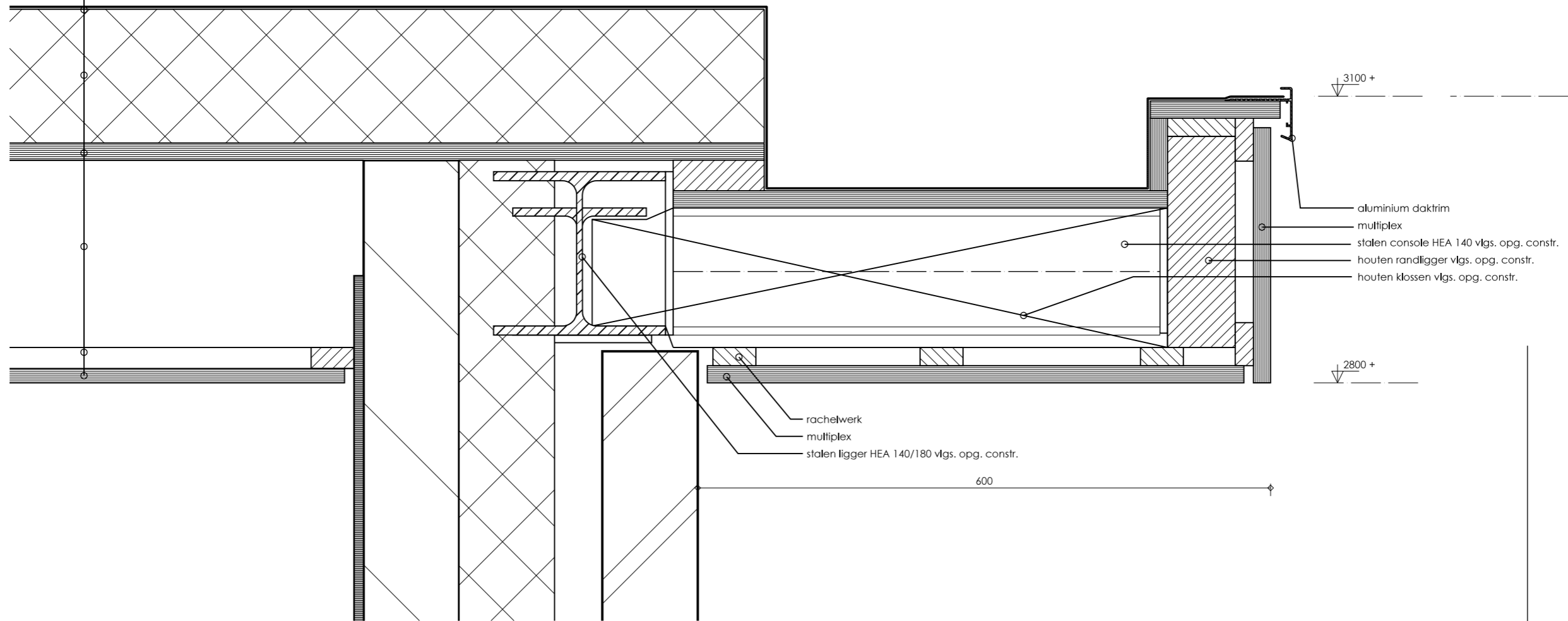

schaal
 1:5
 datum
 16-01-2024
 gewijzigd
 A
 B
 C
 D
 E
 F
 detail
V10

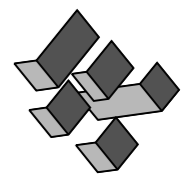
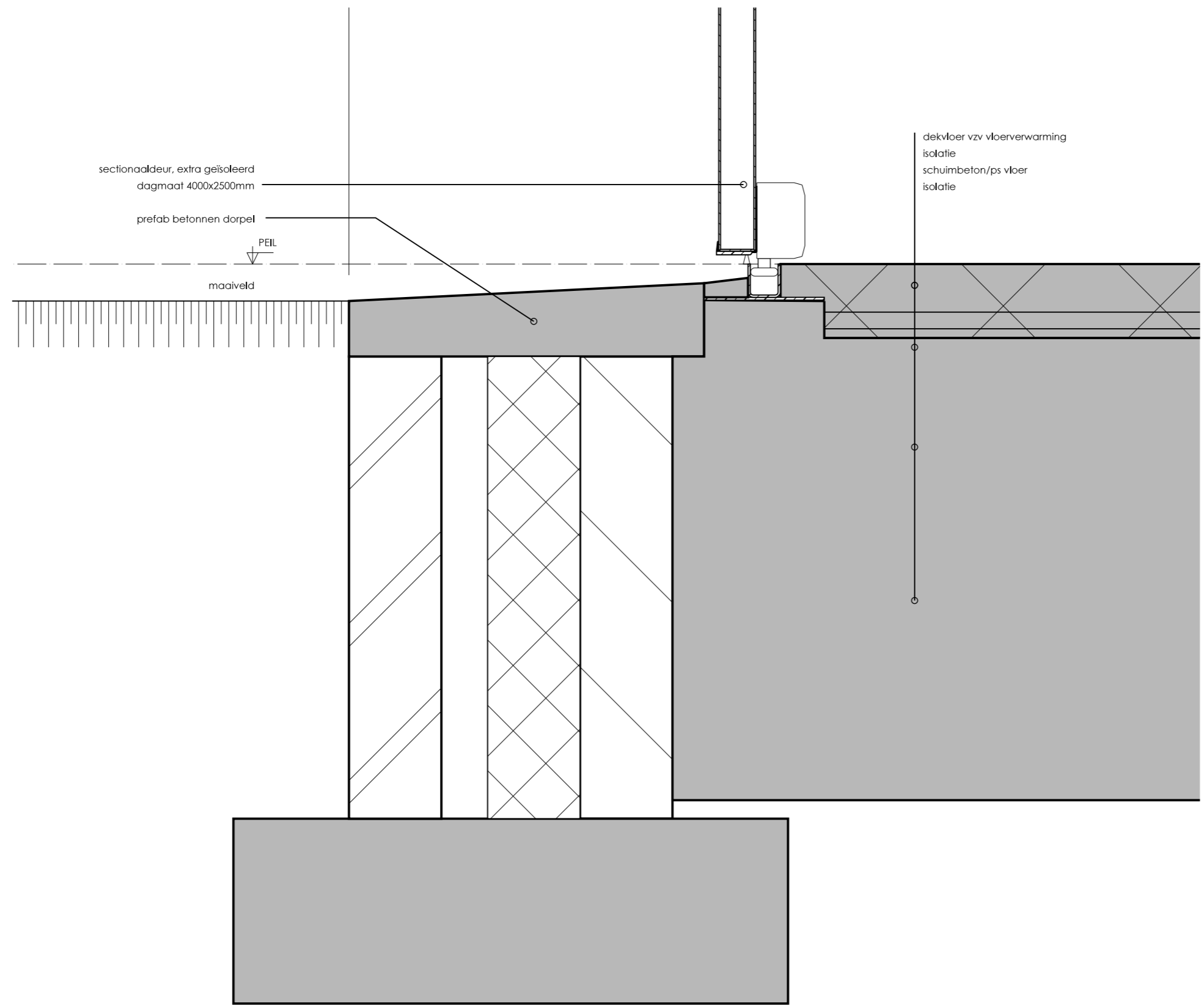

schaal
 1:5
 datum
 16-01-2024
 gewijzigd
 A
 B
 C
 D
 E
 F
 detail
V11

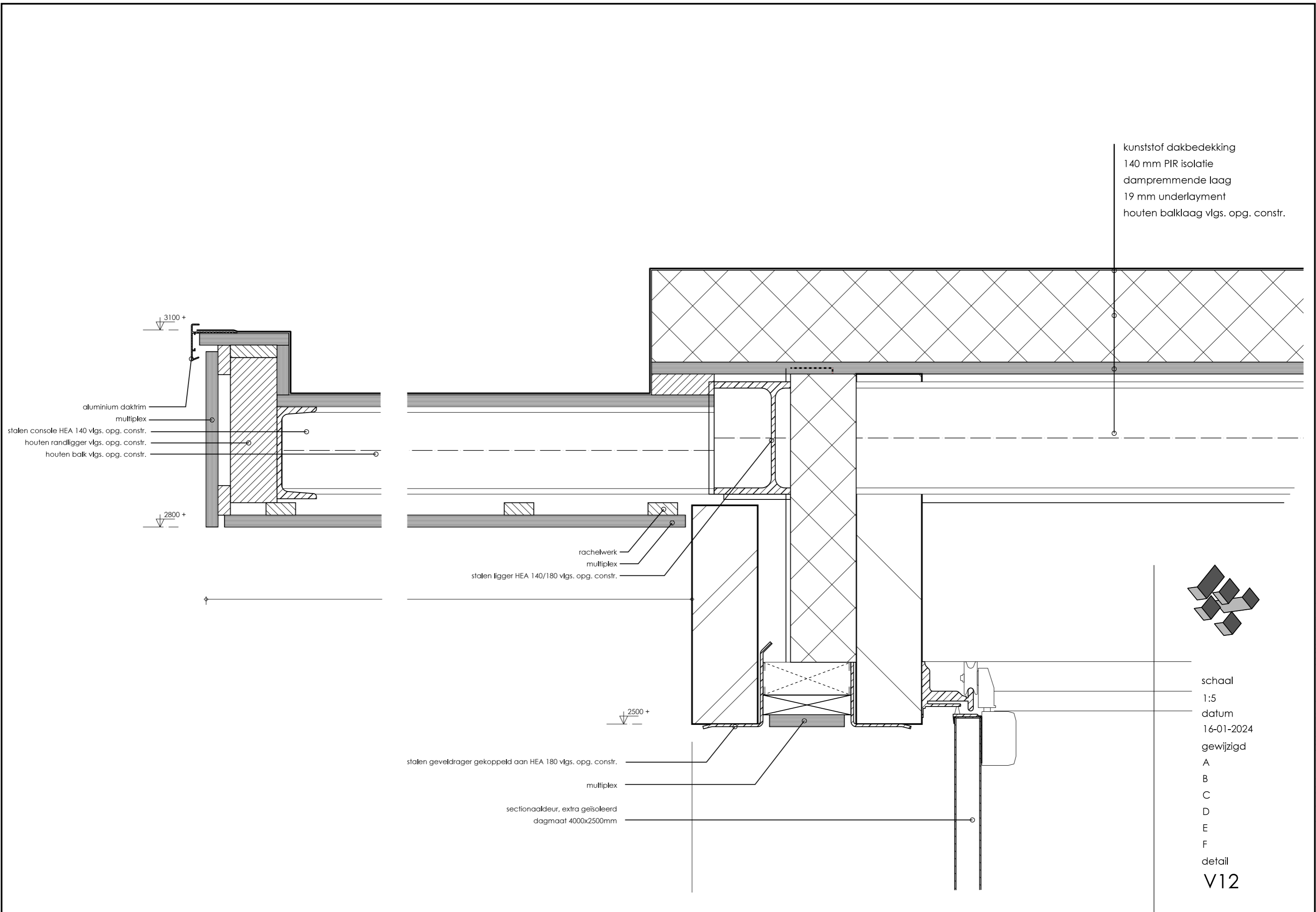

kunststof dakbedekking
 140 mm PIR isolatie
 dampremmende laag
 19 mm underlayment
 houten balklaag vlg. opg. constr.

3100 +
 aluminium daktrim
 multiplex
 stalen console HEA 140 vlg. opg. constr.
 houten randligger vlg. opg. constr.
 houten balk vlg. opg. constr.
 2800 +

rachelwerk
 multiplex
 stalen ligger HEA 140/180 vlg. opg. constr.

2500 +
 stalen geveldrager gekoppeld aan HEA 180 vlg. opg. constr.
 multiplex
 sectionaaldeur, extra geïsoleerd
 dagmaat 4000x2500mm

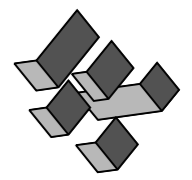

schaal
 1:5
 datum
 16-01-2024
 gewijzigd
 A
 B
 C
 D
 E
 F
 detail
V12

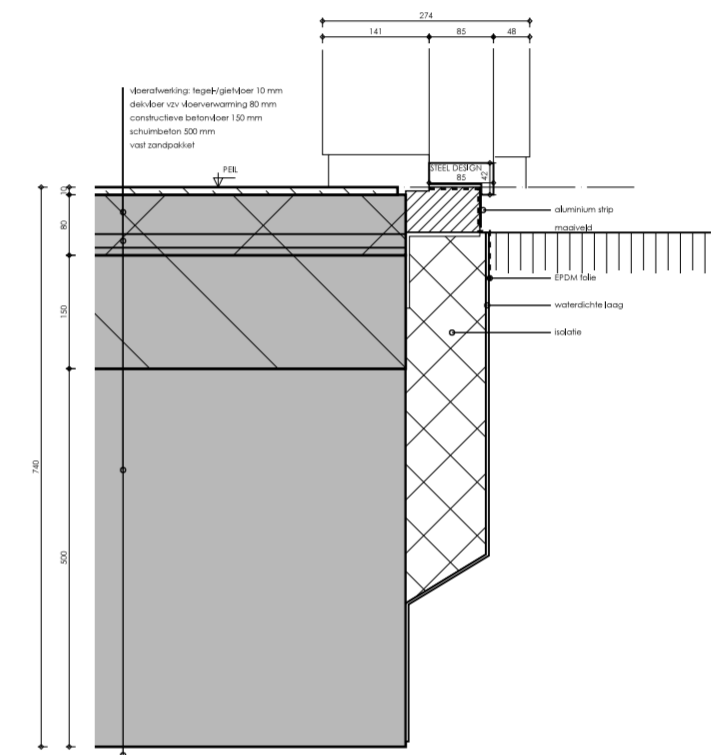
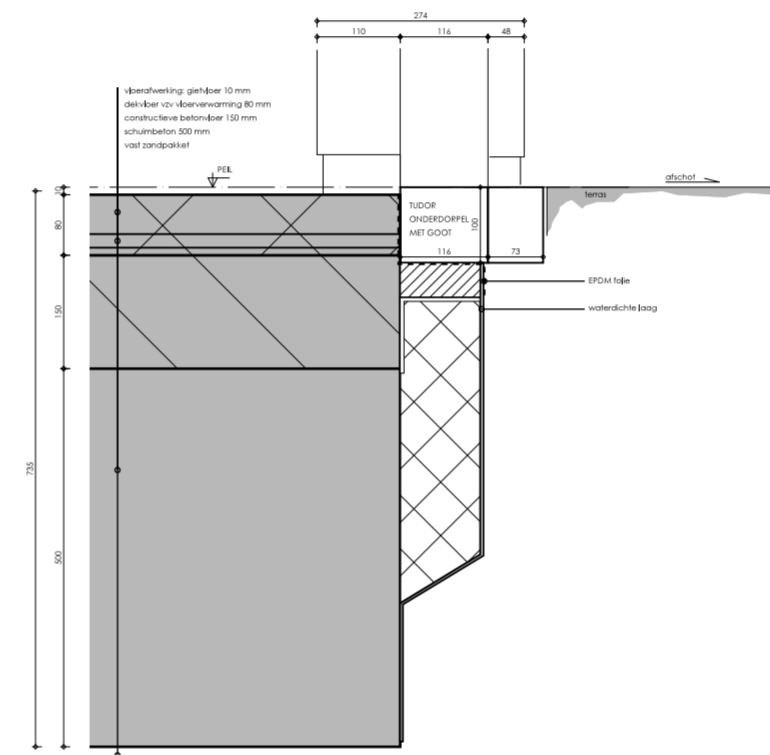
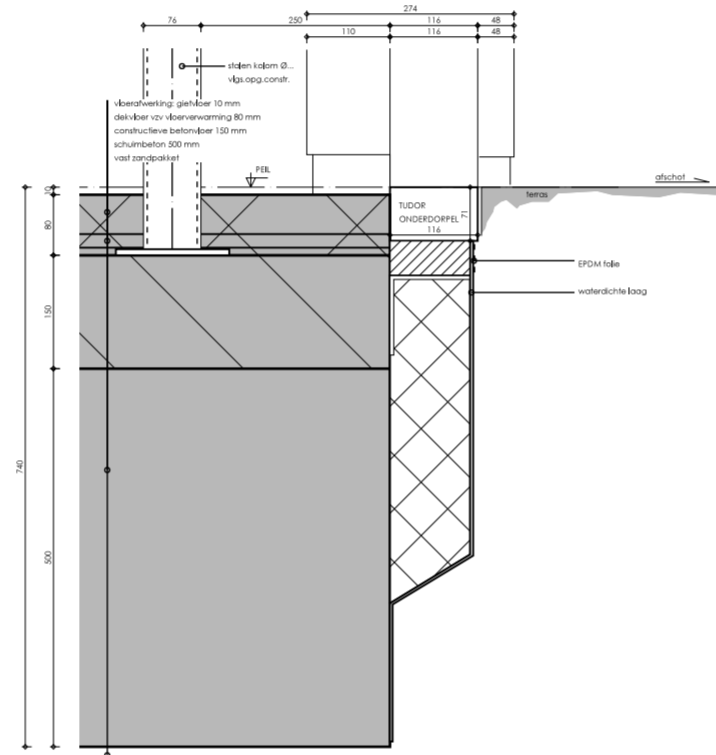
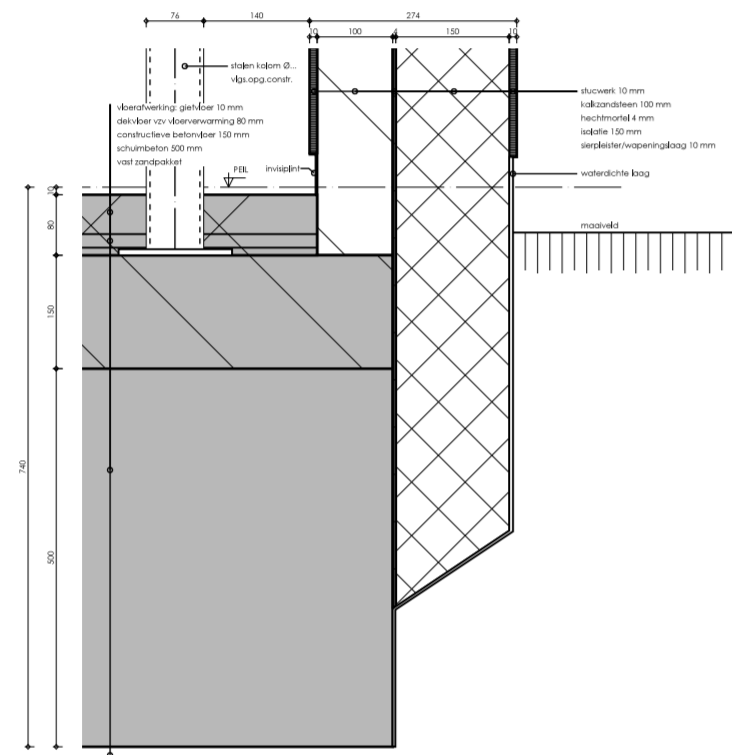
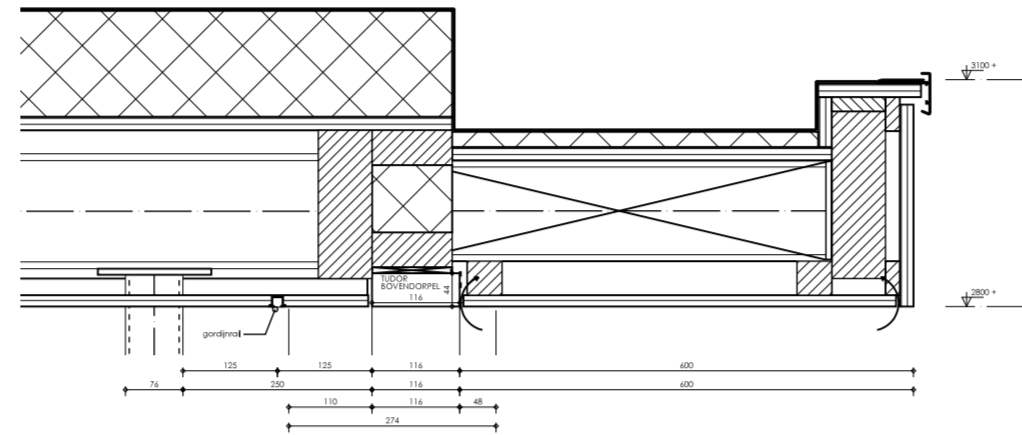
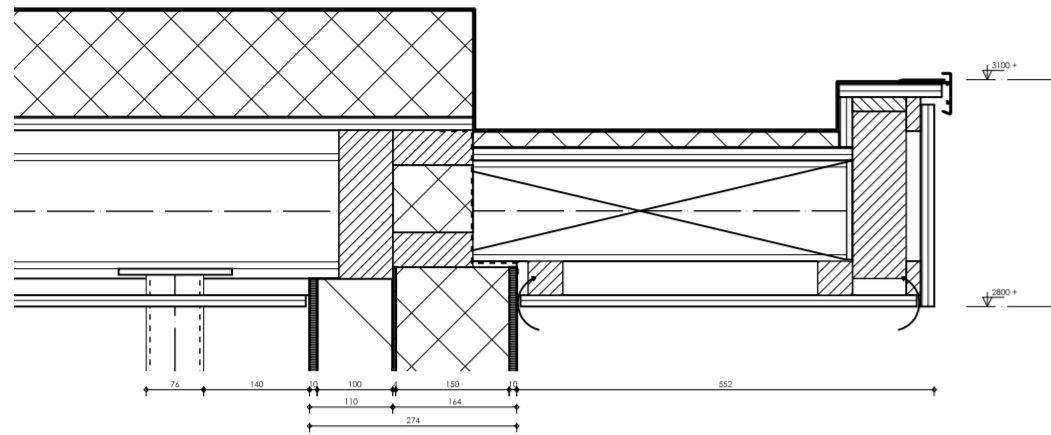

CONCEPT



Bovenweg 29
6721 HV Bennekom

tel (0318) 493666
info@degijt.nl
www.degijt.nl

opdrachtgever
Landheer/Bremmers
project
Verduurzaming woonhuis
onderdeel
Opzet details

ontwerp
getekend
W. van den Brink

schaal
1:10

formaat
A2

nummer
23055
datum
02-05-2024
gewijzigd

blad
WE-10

bestandsnaam: F:\PROJECT\Uit-Be-Lw\23055 Dikkenbergweg_25\23055_10blad WE10.DWG